

NEXT
proaudio
www.next-proaudio.com

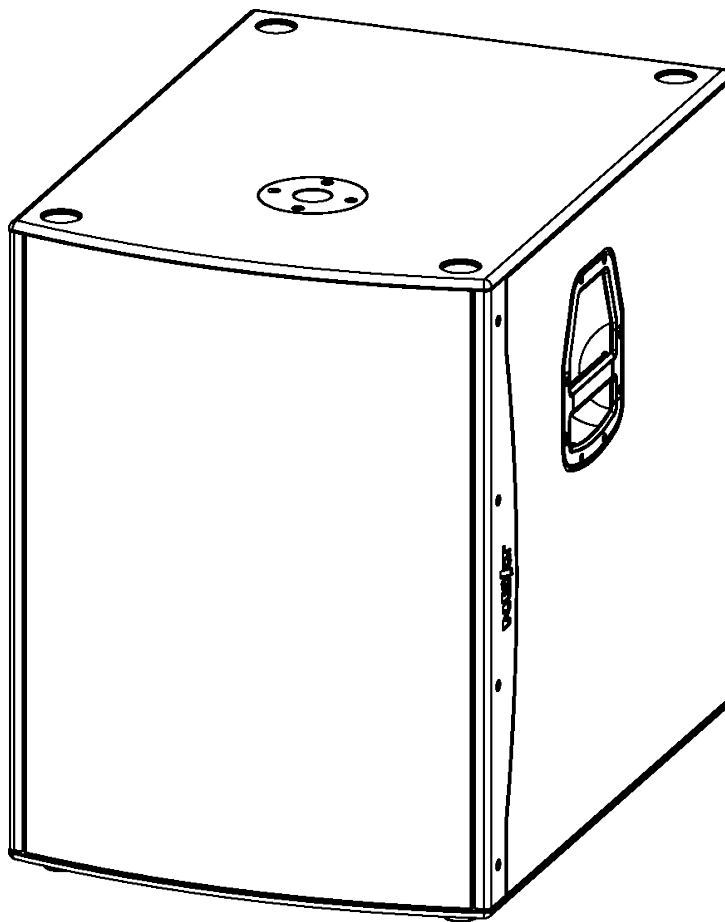

PFA18s/PFA18sp
ACTIVE/Passive Front-Loaded
Subwoofer

USER MANUAL

V201610

CONTENTS

INTRODUCTION	- 1 -
UNPACKING	- 1 -
PFA SERIES OVERVIEW	- 1 -
SAFETY FIRST	- 2 -
PFA18s POWER AMPLIFIER AND DSP	- 4 -
PFA18sp	- 5 -
WARRANTY	- 6 -
TECHNICAL SPECIFICATIONS	- 6 -
CONTACTS	- 8 -

INTRODUCTION

Thank you for purchasing a NEXT PFA18s(p) **ACTIVE**/Passive Front-Loaded High Subwoofer. This manual will provide you with useful and important information about your PFA18s(p) element. Please devote some time reading this manual, and keep it at hand for future reference. NEXT-proaudio is concerned with your safety and well-being, so please follow all instructions and heed all warnings. Also, a better understanding of some specific features of the PFA18s(p) will help you to operate it to its full potential. With a continuous evolution of techniques and standards, NEXT-proaudio, reserves the right to change the specifications of its products without early warning. For the most current data, please visit our website: www.next-proaudio.com

UNPACKING

NEXT PFA Series systems are built in Europe (Portugal) by NEXT-proaudio, according to the highest standards and thoroughly inspected before they leave the factory. When unpacking your PFA18s, examine it carefully for any signs of possible transit damage and inform your dealer immediately if any such damage has occurred.

It is suggested that you retain the original packaging so that the PFA18s can be repacked in the future if necessary. Please note that NEXT-proaudio and its authorized distributors cannot accept any responsibility for damage to any returned product through the use of non-approved packaging.

PFA SERIES OVERVIEW

NEXT-proaudio engineered the new PFA line of self-powered or passive speaker cabinets, specifically for installations, musicians and DJs who want state-of-the-art acoustics and electronics at a limited budget. This speaker line employs premium-quality multi-plywood with a hardening, durable, and scratch-resistant coating, fully rotatable constant directivity horns to adjust H x V angle coverage and custom made speaker drivers. Manufacturing takes place in Europe at our plant based in Rio Tinto, Portugal.

This series are made up of speakers and subwoofers that bind together forming the perfect combination. Several combinations of speakers and subwoofers can be done in order to satisfy your needs. The active speakers feature a variety of factory presets that allow you to use it like a plug n' play perfect solution for the venue.

The PFA18s is an 18" vented direct-radiator exhibiting outstanding transient response and capable of delivering very high sound pressure levels.

SAFETY FIRST

Please pay close attention to this chapter. Failure to comply with these instructions may result on injury or death.

DANGER – HEARING DAMAGE

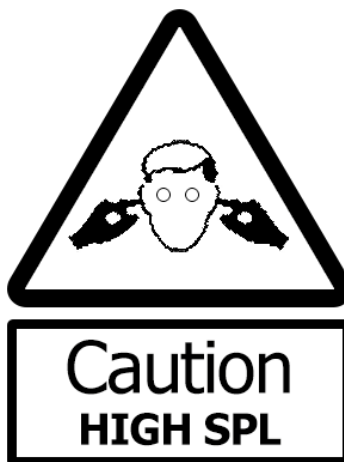

NEXT PFA Series systems are capable of producing extremely high sound pressure levels and should be used with care. Hearing loss is cumulative and can result from levels above 90dB if people are exposed for a long period. Never stand close to loudspeakers driven at high levels.

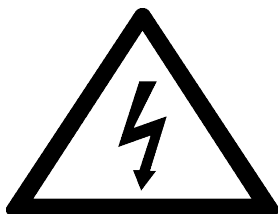

CAUTION

**RISK OF ELECTRIC SHOCK
DO NOT OPEN**



**TO REDUCE THE RISK OF ELECTRIC SHOCK, DO NOT REMOVE COVER
NO USER SERVICEABLE PARTS INSIDE
REFER SERVICE TO QUALIFIED PERSONNEL**

- Do not use your PFA18s near any sources of water, like swimming pools, lakes, water streams, exposed to rain, high humidity environments or any other source of water or moisture.
- Use only a soft dry cloth to clean your PFA18s.
- Never place your PFA18s in a way that prevents air flow near the amplifier. A minimum clearance distance of 6cm should be kept between the amplifier and any near surface.
- Never use your PFA18s too close to any heat source, such as radiators, or any other device that produces heat.
- When mounted on a pole, always ensure that the floor or structure where the stack will take place is even and can withstand the weight.
- Place cables in a way that they do not present a trip hazard.
- Do not place any objects on top of the stack, they can fall accidentally and cause injuries.
- Do not attempt to move the enclosures while connected.
- Do not attempt to service the PFA18s beyond what is described in this manual. All other service or repair of this product should be carried only by qualified personnel.
- To prevent electric shock, do not use any extension cord, receptacle or other outlets where the blades of the connectors cannot be fully inserted.
- Precautions should be taken to prevent grounding failure or polarity switch.
- It is advised to unplug the PFA18s during storms or when not in use for a long period of time.

RIGGING AND SUSPENSION SAFETY CONSIDERATIONS

PFA Series enclosures are designed for portable applications, but can be suspended by means of the threaded inserts provided. These enclosures are fitted internally with steel corner reinforcement brackets to ensure that each cabinet is strong enough to be hung from its top.

- Before rigging or suspending NEXT PFA Series systems, inspect all components and all hardware for any signs of damage or missing parts. If you find any damaged, corroded or deformed parts, **do not use them**, replace them immediately.

NEXT PFA18s/PFA18sp - User Manual

www.next-proaudio.com

- Do not use hardware that isn't load rated or that its' rating is not enough to handle the system's weight with a good safety factor (minimum 4:1).
- Suspended systems installation should only be carried out by qualified personnel.
- Always use adequate protective clothing and equipment to prevent possible injuries.
- Be sure you understand all local and national regulations regarding equipment installation.

PFA18s POWER AMPLIFIER AND DSP

The PFA18s as all PFA series models, was designed to achieve a simple to use and deploy versatile system. The amplifier is designed to power not only the PFA18s itself, but also any passive satellite or group of satellites, as long as the minimum total impedance doesn't reach below 4Ω. The PFA18s, like all PFA series models, is prepared to be completely plug' n play, having already six pre-determined configurations that cover almost all situations. But if you're not happy with any of those, there are also two available user defined configurations, which can be used to adapt the system to your needs using the NEXT-proaudio SOUNDWARE¹ software and the supplied RS485 to USB converter.

Here is a brief description of the amplifier panel:

- 1- Signal Input/Output
- 2- Level Adjustment Potentiometer
- 3- Preset Selector
- 4- RS485 Communication Interface
- 5- List of Available Presets
- 6- Satellite Output
- 7- AC Mains Power Input/Output
- 8- Protection Circuit Breaker
- 9- Power On/Off Switch



Never operate the PFA series Speakers in a way that maintains the Limiter Led consistently on.

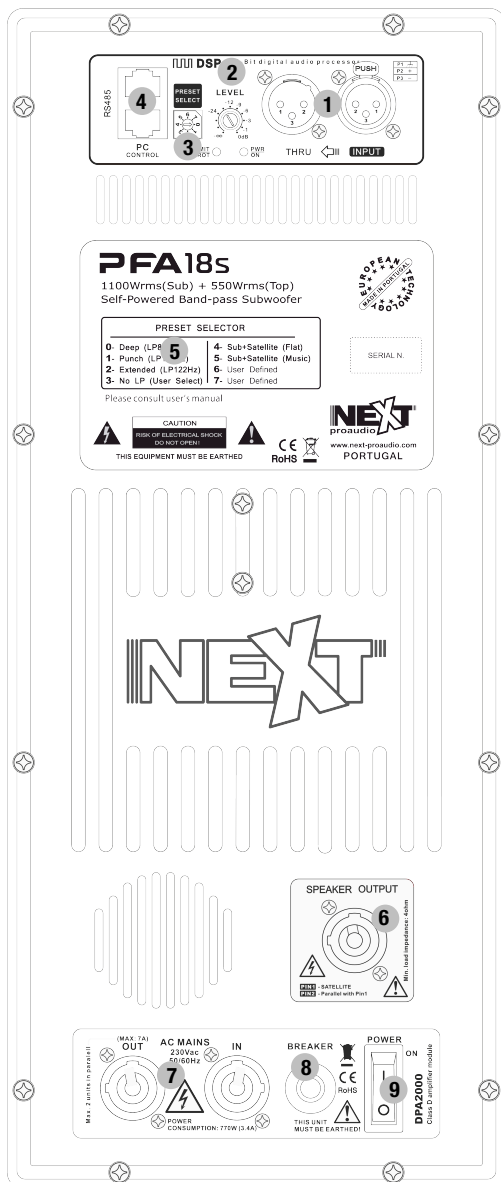

¹ Download NEXT-proaudio SOUNDWARE at www.next-proaudio.com/downloads

PFA118s Preset List:

- 0- Deep (LP80Hz): Low-pass filter at 80Hz 24dB/Oct Linkwitz-Riley
- 1- Punch (LP100Hz): Low-pass filter at 100Hz 24dB/Oct Linkwitz-Riley
- 2- Extended (LP122Hz): Low-pass filter at 122Hz 24dB/Oct Linkwitz-Riley
- 3- No LP (User Select): A Low-pass filter can be defined by the user accordingly to their needs
- 4- Sub+Satellite (Flat): Flat frequency response with the satellite designated on "Programmed Satellite" label
- 5- Sub+Satellite (Music): Frequency response adapted for music reproduction with the satellite designated on "Programmed Satellite" label (Ear compensation, due to high SPL levels, at the mid-high frequency range)
- 6 / 7- User Defined: Free memory for user storage (OUTPUT is muted by default)

PFA18sp

The PFA18sp is the passive version of the PFA18s. Able to deliver an extremely high output and dynamics for its size, extreme linearity and fidelity, is one of the best solutions in its class, in terms of price/quality ratio on the market. PFA18sp is an 8Ω speaker with 1000W resulting in an extremely high power signal output. The speaker must be connected using a 4-point SpeakON connector on 1+ / 1- speakON points. This subwoofer can be used to complement the PFA full-range speaker extending its bandwidth.

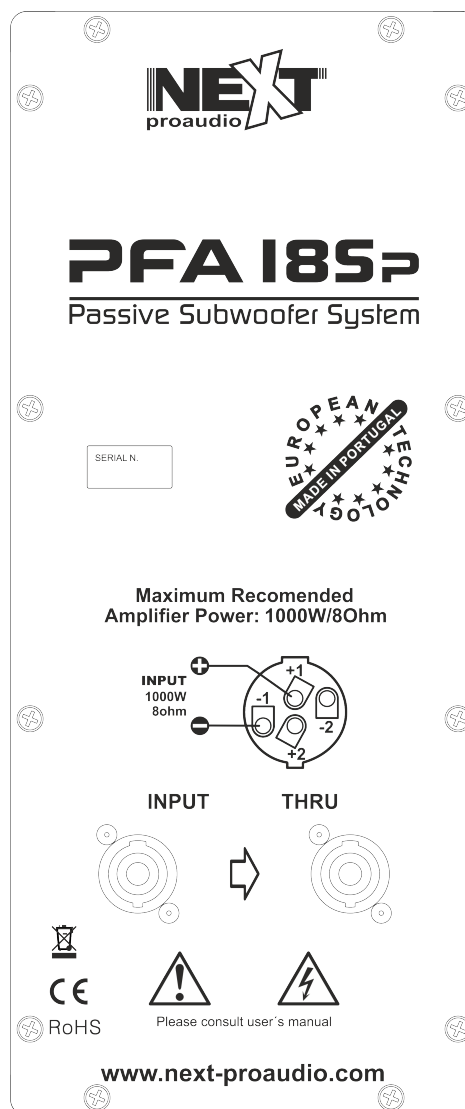

WARRANTY

NEXT-proaudio's products are warranted, by NEXT-proaudio, against manufacturing defects in materials or craftsmanship over a period of 5 years for the passive loudspeakers, and 2 years for all other products counting from the date of original purchase. The original receipt of purchase is mandatory for warranty validation purposes, and the product must have been bought from a NEXT-proaudio authorized dealer.

The warranty can be transferred to a subsequent owner during the warranty period; however, this cannot extend the warranty period beyond the original warranty period of five years from the original date of purchase stated on the NEXT-proaudio's invoice.

During the warranty period NEXT-proaudio will, at its own discretion, either repair or replace a product which prove to be defective provided that the product is returned in its original packaging, shipping prepaid, to an authorized NEXT-proaudio service agent or distributor.

NEXT-proaudio cannot be held responsible for defects caused by unauthorized modifications, improper use, negligence, exposure to inclement weather conditions, act of God or accident, or any use of this product that is not in accordance with the instructions provided by this manual and/or NEXT-proaudio. NEXT-proaudio is not liable for consequential damages.

This warranty is exclusive and no other warranty is expressed or implied. This warranty does not affect your statutory rights.

TECHNICAL SPECIFICATIONS

PFA18s Block Diagram

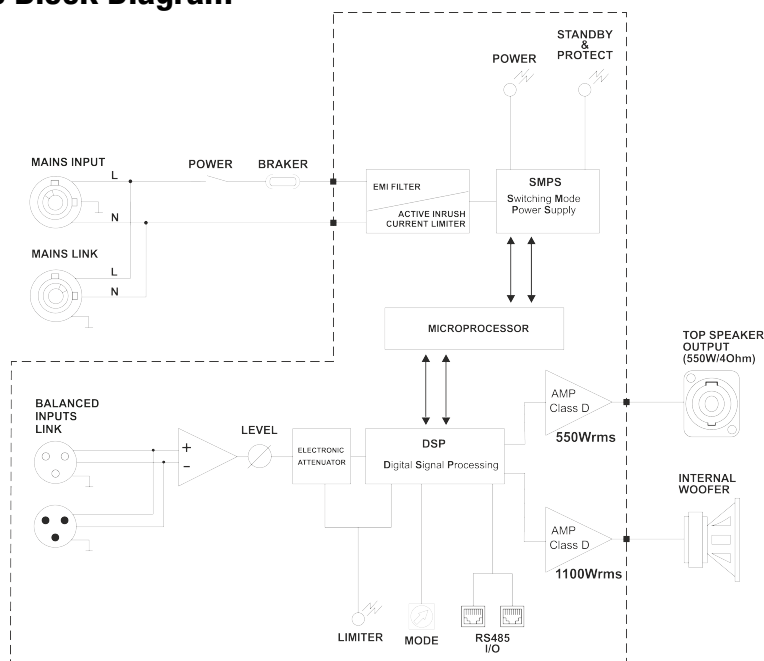

NEXT PFA18s/PFA18sp - User Manual

www.next-proaudio.com

NEXT PFA18s TECHNICAL SPECIFICATIONS	
Speaker Type	ACTIVE Reflex Subwoofer
Frequency Response (-6dB)	38Hz – X-Over
Calculated Max. SPL (Cont/Peak)	133dB / 139dB (Half-Space)
Components	1 x 18" Long Excursion / 4" Voice Coil Custom Speaker
Amplifier Technology	2 Channel Switched Mode Class D with DSP (1650W)
Power to Int. Speaker (Sub) (RMS)	1100W
Power to Ext. Speaker (4Ω Sat) (RMS)	550W
Construction	18mm Multi-laminate Birch Plywood, Screwed and Glued
Finish	Black Textured Scratch Resistant Paint
Grille	Steel, Black Finish (also available in other colours)
Dimensions (W x H x D)	525 x 703 x 735 mm
Net Weight	47.1 kg
Shipping Weight	50.7 kg

NEXT PFA18sp TECHNICAL SPECIFICATIONS	
Speaker Type	Passive Reflex Subwoofer
Frequency Response (-6dB)	38Hz – 270Hz
Calculated Max. SPL (Cont/Peak)	133dB / 139dB (Half-Space)
Components	1 x 18" Long Excursion / 4" Voice Coil Custom Speaker
Program Power	1000W
Nominal Impedance	8Ω
Construction	18mm Multi-laminate Birch Plywood, Screwed and Glued
Finish	Black Textured Scratch Resistant Paint
Grille	Steel, Black Finish (also available in other colours)
Dimensions (W x H x D)	525 x 703 x 735 mm
Net Weight	44. kg
Shipping Weight	47.5 kg

DIMENSIONS

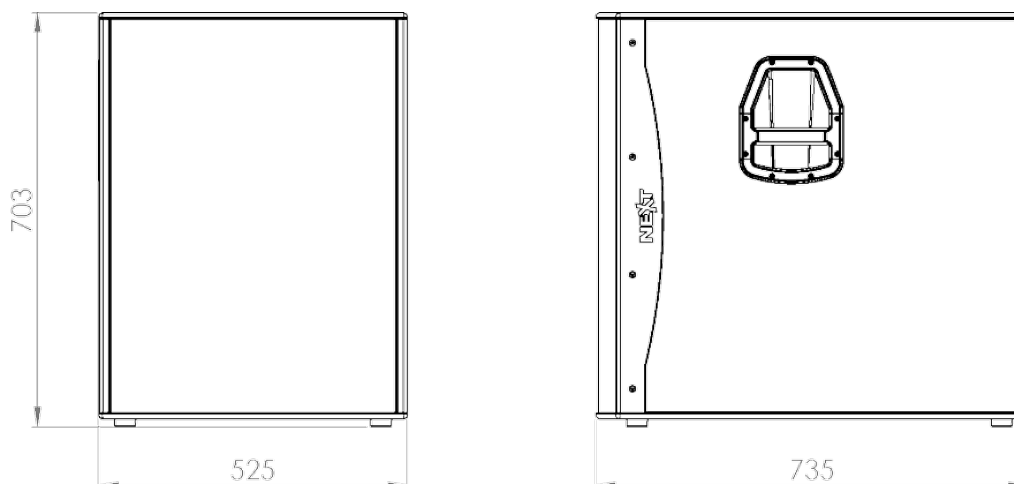

CONTACTS

In case of any doubts or any information just:

Write us:

NEXT-proaudio
Rua da Venda Nova, 295
4435-469 Rio Tinto
Portugal

Contact us:

Tel. +351 22 489 00 75
Fax. +351 22 480 50 97

Send an e-mail:

info@next-proaudio.com

Search our website:

www.next-proaudio.com

Follow us on:

Facebook: facebook.com/nextproaudio

Instagram: instagram.com/nextproaudio

LinkedIn: linkedin.com/company/next-proaudio

Twitter: twitter.com/next_proaudio

Youtube: youtube.com/user/NEXTmanufacturer