

OUTLINE GTO
FULL RANGE LINE ARRAY ELEMENT
MANUAL FOR USE, MAINTENANCE, CONTROL &
ELECTRO-ACOUSTIC INSTALLATION



OUTLINE GTO LINE ARRAY
MANUAL FOR USE, MAINTENANCE, CONTROL & ELECTRO-ACOUSTIC INSTALLATION



OUTLINE GTO LINE ARRAY
MANUAL FOR USE, MAINTENANCE, CONTROL & ELECTRO-ACOUSTIC INSTALLATION



OUTLINE GTO LINE ARRAY
MANUAL FOR USE, MAINTENANCE, CONTROL & ELECTRO-ACOUSTIC INSTALLATION



INTRODUCTION	5
PRODUCT DESCRIPTION.....	6
COMPONENT DESCRIPTION	8
Mechanism.....	8
Cabinet.....	10
ELECTRO-ACOUSTIC STRUCTURE & DESIGN	11
High Frequency Section	12
Mid Frequency Section.....	12
Low Frequency section	12
CONNECTIONS AND POWERING	14
Assessing energy consumption	18
BLOCK DIAGRAMS.....	19
System regulation.....	23
Technical data	24
Dimensions	25
APPENDIX 1.....	26
OpenArray – 3D simulation software.....	26
Open Mechanics	37
APPENDIX 2.....	38
Inspection, maintenance and repair work.....	38
Complete spare parts list:.....	39
APPENDIX 3.....	41
Calculating the parameters for positioning subwoofers in a “cardioid” configuration - Theory	41
Practical procedure	42

INTRODUCTION

OUTLINE GTO is the result of the need to integrate in a system with top grade performance as far as both quality and quantity are concerned a series of functions required by the market and by specific users' needs. Some of the choices taken at the design stage were therefore the result of compromises that were carefully considered before being adopted to ensure excellent results from the point of view of overall requirements and not for individual functions. For example: the rectangular lines with front splay angle adjustment, instead of raked lines with rear adjustment, were chosen for the fundamental need for systems with these dimensions and weights to be transported stacked (with 3/4 elements) on special trolleys, enabling unbeatable set-up speed compared to the classic "array train" modus operandi. Another example is in the choice of material for the mechanical connector plates, in which an aluminium alloy with high mechanical resistance and thick anodized coating is justified by the weight : performance ratio (mechanical, weather and wear resistance), which ensures great improvement, in spite of the additional cost.

The aforementioned functions are found in the following criteria:

- type of product: wide-range Line Array element (larger than the "medium-sized" models, such as "Butterfly" or "Mantas");
- mechanical ability to safely fly twenty four systems (in normal conditions)
- completely integrated hardware;
- possibility of vertically aiming the array both upwards and downwards;
- two types of handling possibilities:
 - stacked 3-up (with dedicated trolley);
 - single elements for an array "train" installation (with the trolley fitted on the front);
- easily handled single elements (practical ergonomic handles), even when separated from the other array elements;
- rapid, easy array set-up and dismantling;
- easy precise splay angle adjustment with the smallest possible steps;
- weight of single elements has been kept to a minimum;
- dimensions that take into consideration trucking needs, matching other OUTLINE products (element width 120 cm, including trolley footprint and pins fitted);
- full electro-acoustic compatibility (module and phase response) with Butterfly and Mantas systems for combining the systems in complex PAs including UP-FILL, DOWN-FILL and SIDE-FILL sections, DELAYs, etc...
- possibility of adding Mantas and Butterfly elements as DOWN-FILL elements with a special accessory;
- possibility of adding Butterfly elements as UP-FILL enclosures (above the frame) with a special accessory;
- mounting points on the Main Frame for additional accessories;
- high headroom;
- distortion reduced to a minimum;
- facilitated inspection, control, maintenance and/or repair work.

PRODUCT DESCRIPTION

GTO was conceived, designed and manufactured to have a response that enables to install Line Arrays with passband extension at low frequencies down to 50 Hz ($\pm 3\text{dB}$). The application of the well-known (patented) DPRWG technology, with which we have wide experience and which has been further improved, has enabled to achieve new goals in terms of performance as far as both quality and quantity are concerned.

For in-depth details on this, see the “Butterfly system white paper” by Guido Noselli.

The mid section, for its electro-acoustic compatibility and excellent operation, is also based on the widely tested “Continuous throat technology” type of band-pass layout (derived from the cabinet shape, which has a utility model patent) of Butterfly and Mantas systems. For the GTO, loudspeakers more suited to the range to be reproduced were chosen, since in this case, as opposed to the Mantas and Butterfly, less extension toward the low frequencies is required. Moreover, the transducer chosen features an extremely linear electro-mechanical response as well as a neodymium magnet with a reinforced cooling circuit that enables the weight of the entire system to be considerably reduced without lowering performance. The dimensions of the electro-acoustic system of the mid section, combined with the precise design of the output ports and their carefully designed and experimented positioning, create perfect response continuity with the adjacent sections (HF and LF) as far as both on-axis and beam-width measurement are concerned.

The low frequency section features hybrid acoustic loading, where a chamber in front of the woofer functions as band-pass loading with semi-direct radiation and as an acoustic impedance adaptor (horn) for the reflex vents. This acoustic “architecture” ensures a gain in transduction efficiency at low frequencies with considerably more flexible exploitation of space.

The cabinet is very sturdy and light, considering the functions required, thanks to a careful layout of the internal bracing and structural components. The design also took into consideration the repeatability of the component dimensions, in order to optimize factory productivity. In fact, specific equipment was specially designed and manufactured for both the construction of the cabinet in our in-house carpentry workshop and for factory production, in order to “filter” every possible error at each stage, enabling to reach the end of the line with a finished product identical to the design.

The high quality paint finish is wear-resistant and weather-proof. However, to avoid the risk of considerable damage, it is advisable not to leave the product under direct rain for long periods.

The protective grilles are in non-resonant steel combined with a protective barrier in acoustically transparent open-cell material, for better UV ray and (rain) water protection.

All the hardware for connection with the other array elements is completely integrated. The connector brackets are in special highly resistant steel. The load-bearing side plates are in highly resistant aluminium alloy with surface hardening treatment to obtain a rigid structure highly resistant to stress, weather conditions, impact and/or wear. The coupling of the two plates, with a suitably shaped layer of birch plywood between them, ensures the structure excellent characteristics in terms of weight:performance ratio.

All connector pins are retained by lanyards to prevent loss. They also have opportune transport positions in the side connector flanges.

The following is an illustrative diagram of GTO with its main components.

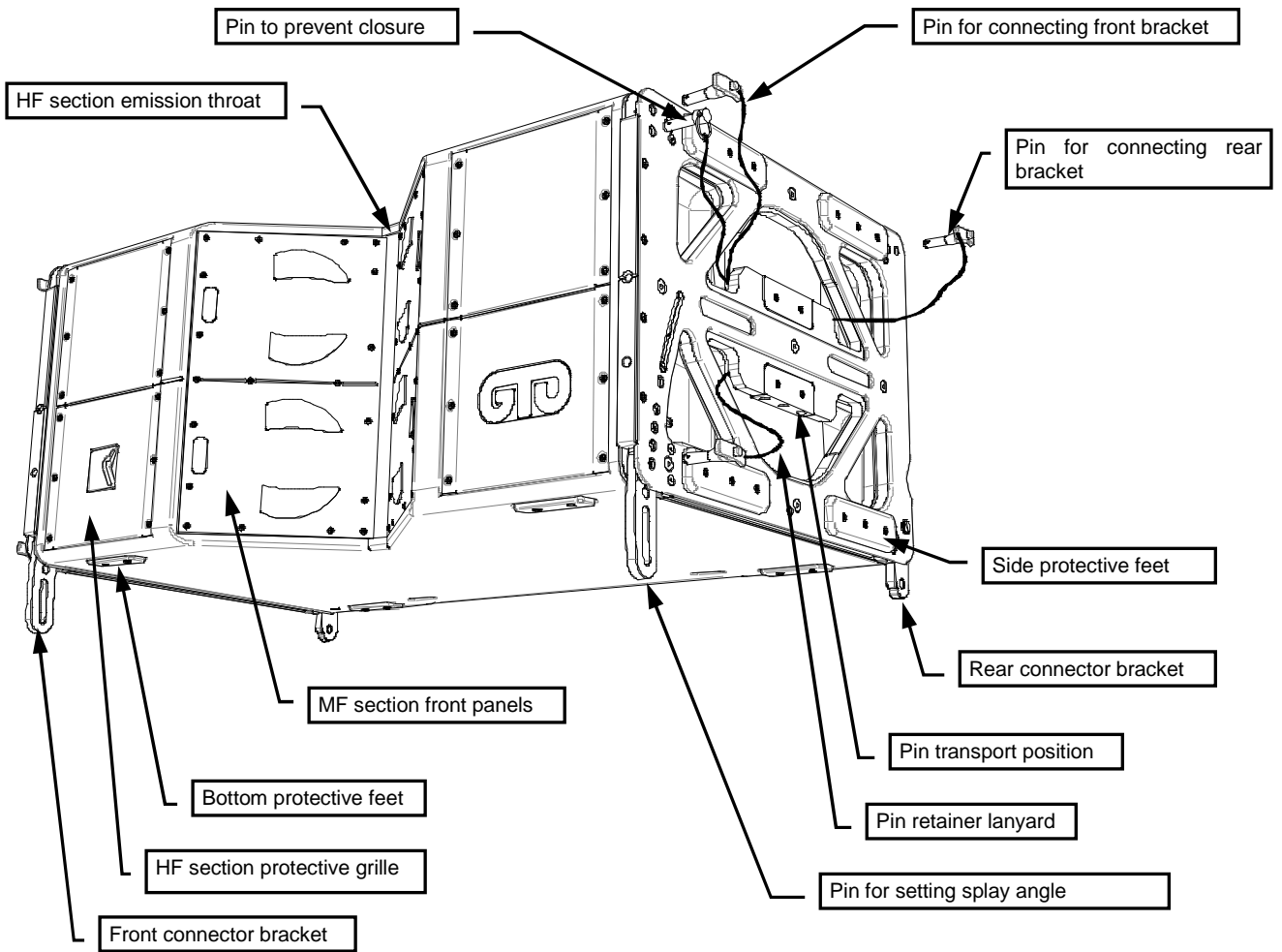

Figure 1 – Front view

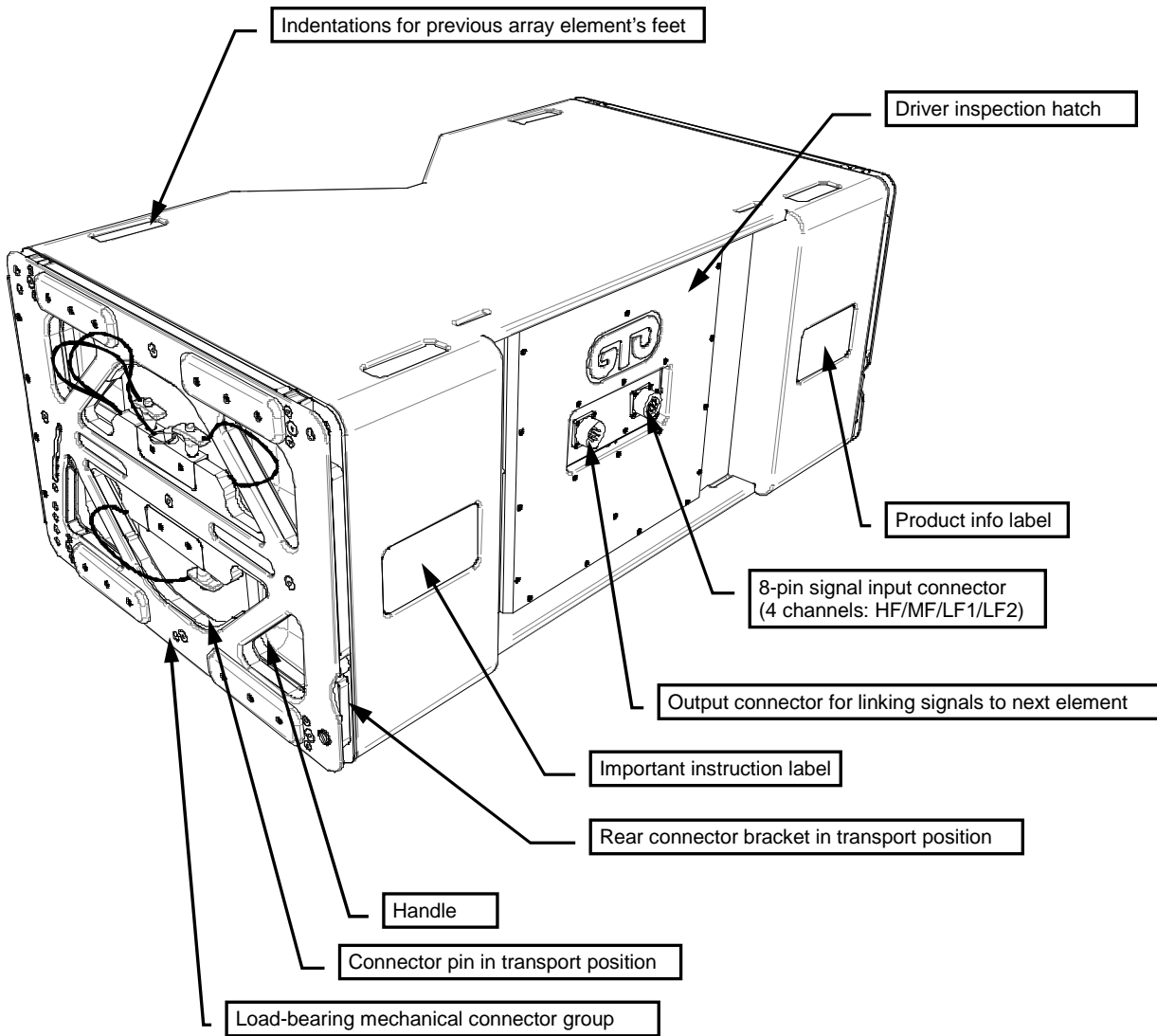

Figure 2 - Rear view

COMPONENT DESCRIPTION

Mechanism

The mechanical part of GTO (Figure 1 and Figure 2) is the key aspect of the system's operation as far as the extremely demanding needs for overall application standards are concerned: storage, transport, handling, installation, safety (see above diagram).

Nothing has been left to chance and numerous trial sessions run on the project, followed by improvements and fine-tuning and, where necessary, even radical changes were made to ensure solutions without any half-measures was reached, considering the apparent incompatibility between the size of the elements in question (96 Kg/212 lb per cabinet) and the need for absolute precision when connecting the elements.

The load-bearing hardware consists in a composite component formed by two external plates in ultra-resistant aluminium alloy with a layer of Baltic birch plywood between them. This composite component holds the brackets connecting the elements in a completely integrated manner. These brackets are in highly resistant steel. The material and type of

surface treatment of the load-bearing elements were selected after extensive research to achieve the best weight : performance ratio. For the load-bearing plates, the result consists in a special high-grade aluminium alloy with a surface treatment that transforms the material into a composite component with the maximum lightness : mechanical performance ratio, including resistance to oxidation (practically impossible) and wear (very high surface hardness). Due to load-bearing needs, as well as compact dimensions and, consequently, little effect on weight, the highly resistant steel used for the connecting brackets was water-jet cut to maintain the material's mechanical properties. The galvanization and following protective finish of the brackets make them highly resistant to oxidation, impact or wear through time.

All the parts' design and finish were conceived to obtain products that are easily handled and can be connected to the adjacent elements with the utmost precision.

Splay angle can be set from 0 to 5° in steps of 0.5°, with an additional position of 0.25°, very useful above all for the first elements of arrays aiming at a considerable distance, where an excessively large step might not allow the design's objective to be achieved. A practical angle indicator enables the bar to be set precisely at the required splay angle. Fitting the splay angle setting pin locks the bracket in the required position.

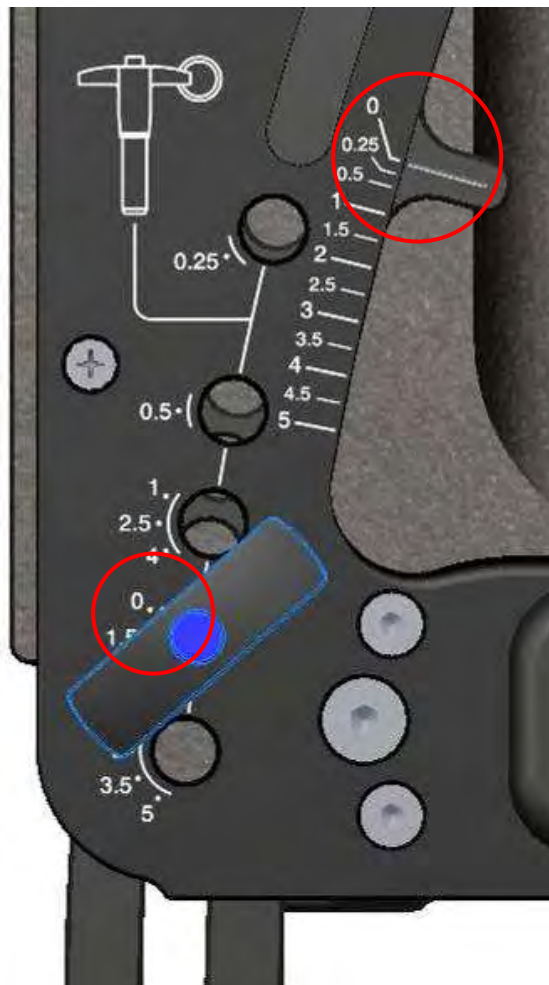

Figure 3 – Example of setting the splay angle

All the aluminium alloy components (including those that are not load-bearing but nonetheless important for mechanical functions) underwent the same hardening treatment to ensure better resistance to wear.

Small practical polyamide feet, on the sides and the bottom of the cabinet, protect it from impacts and friction. The indentations for these feet, on the top of the cabinet, facilitate cabinet stacking as well as the positioning of the Frame on the first enclosure. Another series of small aluminium feet (on the underside) and indentations (on the top) integrated in the side mechanism complete the precise positioning of array elements, to allow splay angles to be set later without any hindrances due to inaccurate reciprocal positioning.

The design of the side load-bearing plates was conceived with a view to facilitating the handling of single elements, of which we give some examples:

- “Single handling” use for “array train” installation
- Test inspections and scheduled maintenance
- Very uneven ground, or where it is impossible to transport enclosures by trolley

The handles’ grips are positioned at 45° to facilitate lifting in both horizontal (single handling) and vertical (stacked handling) positions.

The indications on the side plates are engraved with laser technology to eliminate the risk of cancellation.

The side plates are mounted using equipment specially designed and manufactured to allow the utmost assembly precision and speed and to block any pieces without the necessary precision requisites at the beginning of the manufacturing chain.

Cabinet

The cabinet was conceived to meet all the requisites relative to the real-life use of the product, which is not only limited to when it is actually in operation: sturdiness, structural rigidity (minimization of the loss of acoustic performance), light weight, resistance to impact and friction, resistance to accidental exposure to direct rain, even during handling, minimization of interior destructive reflections and stationary waves, precise dimensions, ergonomics (for easy handling), facilitated work and inspection (ordinary and extraordinary maintenance), ease of precise carpentry shop assembly, manufacturing speed. Loading-bearing mechanism, accessory elements and cabinet are carefully matched to ensure the very best weight : performance ratio.

The water-based paint used to finish the cabinet, combined with previous in-depth impregnation treatment, makes the product particularly resistant to adverse weather conditions as well as accidental scratches and impacts and considerably simplifies any touching up work, should it be necessary.

ELECTRO-ACOUSTIC STRUCTURE & DESIGN

The following is a functional diagram of the division into bandpass sections, followed by the label showing the characteristics of each section:

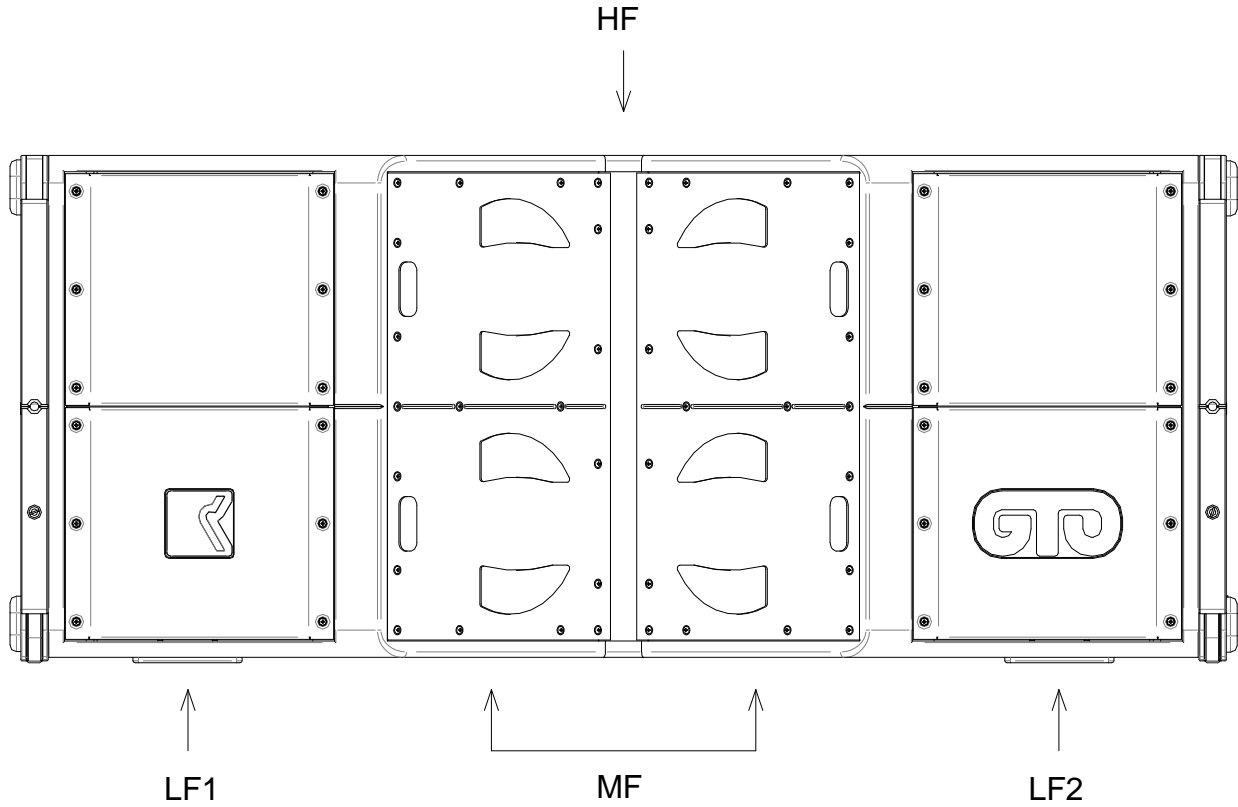

Figure 4

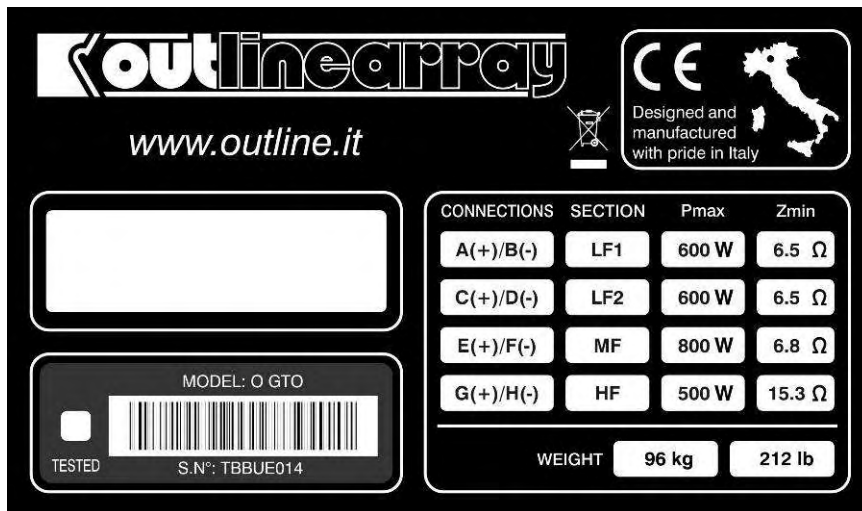

Figure 5 – Technical data label on the rear of the cabinet

High Frequency Section

The driver used in the HF section was specially designed with custom parameters in order to optimize performance in terms of noise and the transfer of energy between the power amplifiers and the enclosures with three GTO elements connected in parallel.

Each driver is combined with a DPRWG to give a cylindrical wavefront at its output, which in turn is connected to the throat of a waveguide for the control of horizontal dispersion (90°). In the case of GTO, further improvement has been obtained by coupling four DPRWG (in pairs) at their output, to increase performance in terms of distortion, power compression, headroom and power handling. In this case too it was necessary to carry out numerous simulations and prepare numerous experimental prototypes to find the best system. A great deal of work also went into the optimization of dispersion, above all based on suggestions received from several sound engineers and PA men following repeated listening sessions in various types of locations (outdoors, indoor sports facilities and arenas). The result consists in a "TRUE LONG THROW" HF section which, used along with an equally effective MF section, gives a high impact even over considerable distances, with excellent dispersion coherence (more than 90°) and clean, coherent, detailed and highly intelligible sound.

Mid Frequency Section

For the mid frequencies, a loudspeaker with excellent sonic characteristics has been adopted, with lower distortion levels (THD), measured at very high SPL, than many similar models. Moreover, the electromechanical characteristics (parameters) of the loudspeaker were established in relation to the type of acoustic loading (bandpass) and the frequency range required (200 – 1000 Hz)

The mid section uses bandpass loading that limits the band reproduced by the loudspeaker by means of a chamber in front of the diaphragm and an output area specially calculated for the necessary low-pass frequency. The shape of the radiation aperture is ideal for maintaining both the function of waveguide for the high frequencies and utmost dispersion coherence. As well as being based on well-ascertained scientific requirements, a great deal of work was also carried out on experimenting various solutions for achieving the best result, due to the need to obtain a dual function from one element.

For the acoustic insulation of the mid-range, a moulded plastic shell was used for the maximum weight : performance ratio, designed and manufactured to obtain all the functions necessary in one device. In fact this "shell" includes the container for easily positioning the sound absorbing material, the position of the rear reflex duct and the acoustic volume necessary for the frequency range used, all in a rigid light component with a shape without any internal reflections.

The emission of the mid frequencies is loaded and projected by the same waveguide with a horizontal dispersion of 90° as is used for the high frequencies; this ensures maximum sonic coherence, electro-acoustic transduction and physical impact over the entire range, which goes from 200 Hz to the top end of the band reproduced by the system (18 kHz)

Low Frequency section

The loudspeakers used for the low frequencies are also the result of in-depth research for the best load/loudspeaker match for use of the required frequency range.

This loudspeaker's characteristics include transient response speed, thanks to its particular electro-mechanical characteristics, and a high excursion with excellent linear characteristics. Cooling has been pushed to the utmost to ensure an excellent capacity for handling high in-coming power with the lowest possible thermal energy build-up, on both the magnetic circuit and the voice coil, thanks to highly efficient self-ventilation circuits.

The electro-mechanical parameters have been optimized for the utmost efficiency (and therefore also the maximum pressure) in the frequency range used.

The purely mechanical characteristics of the loudspeaker are excellent: two spiders with a layer of sandwich silicone between them, for high excursion and lightness:strength ratio, double waterproof treatment of the diaphragm and triple-roll surround for excellent reduction of rocking-motion.

As in the mid section, the hybrid bandpass loading helps to “reject” everything not within the frequency band used, thanks to the LO-PASS acoustic filtering that is added to the electric LO-PASS filtering for a greater frequency *cleanness* in the adjacent bands, reproduced by the other components. At the same time, system efficiency is increased, enabling to reduce thermal stress on the loudspeaker. In fact, everything that is gained in terms of efficiency corresponds to a reduction in the in-coming electric signal to obtain the same result. The position of the LF section’s emission vents, combined with the system’s other components results in a horizontal “LMHML” (Low - Mid - High - Mid - Low) configuration. This ensures control of dispersion coherence, as well as the array’s perfectly symmetric timbre over the whole area covered and in the entire frequency range reproduced. The physical design of the cabinet enables to combine in an extremely effective manner sturdiness, light weight and optimization of acoustic behaviour inside the box (stationary waves, resonance of the sides, etc.).

CONNECTIONS AND POWERING

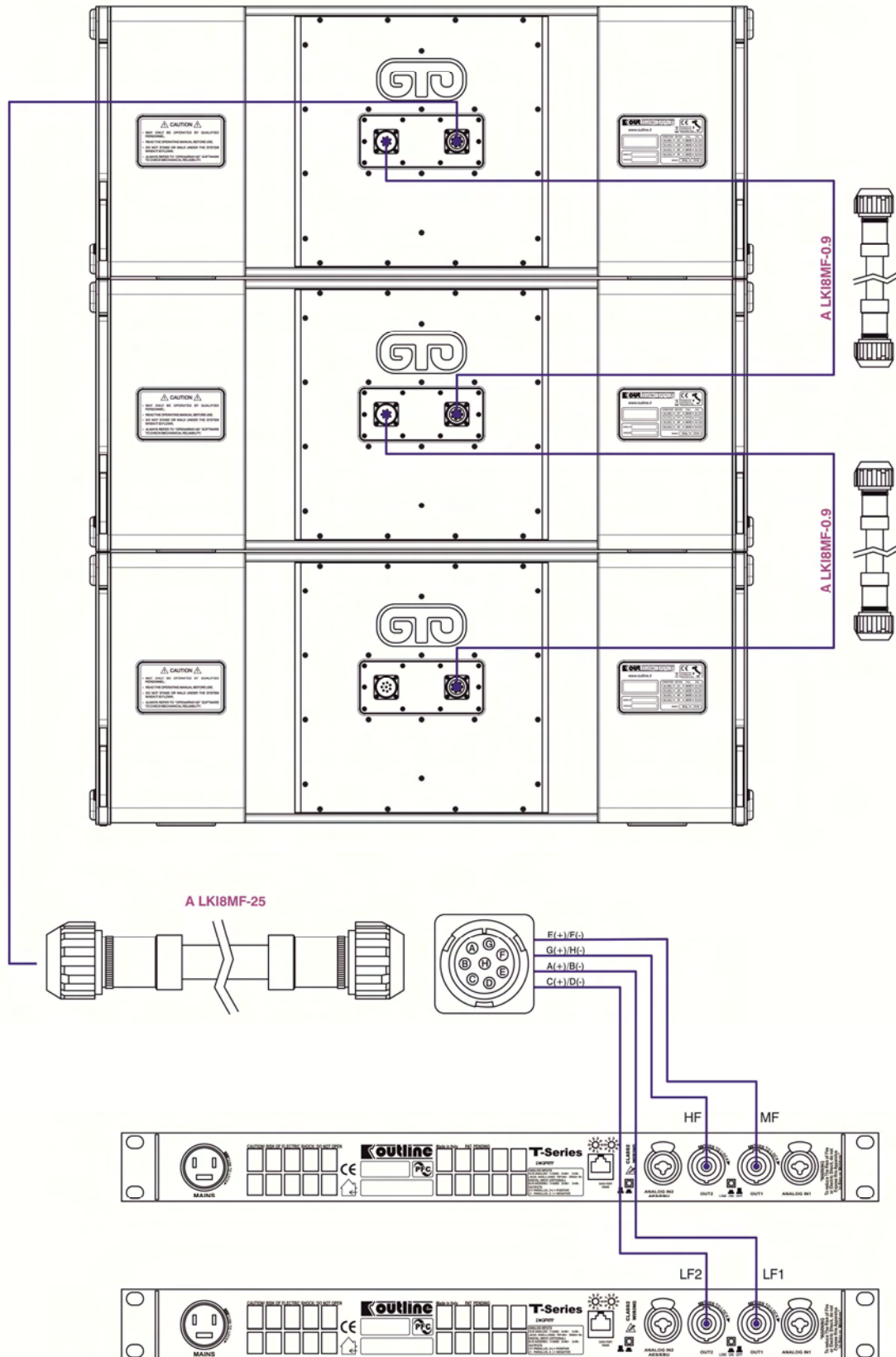

Figure 6 – Connection to power amplifiers

The following is the diagram of the internal wiring between the connector and the loudspeakers:

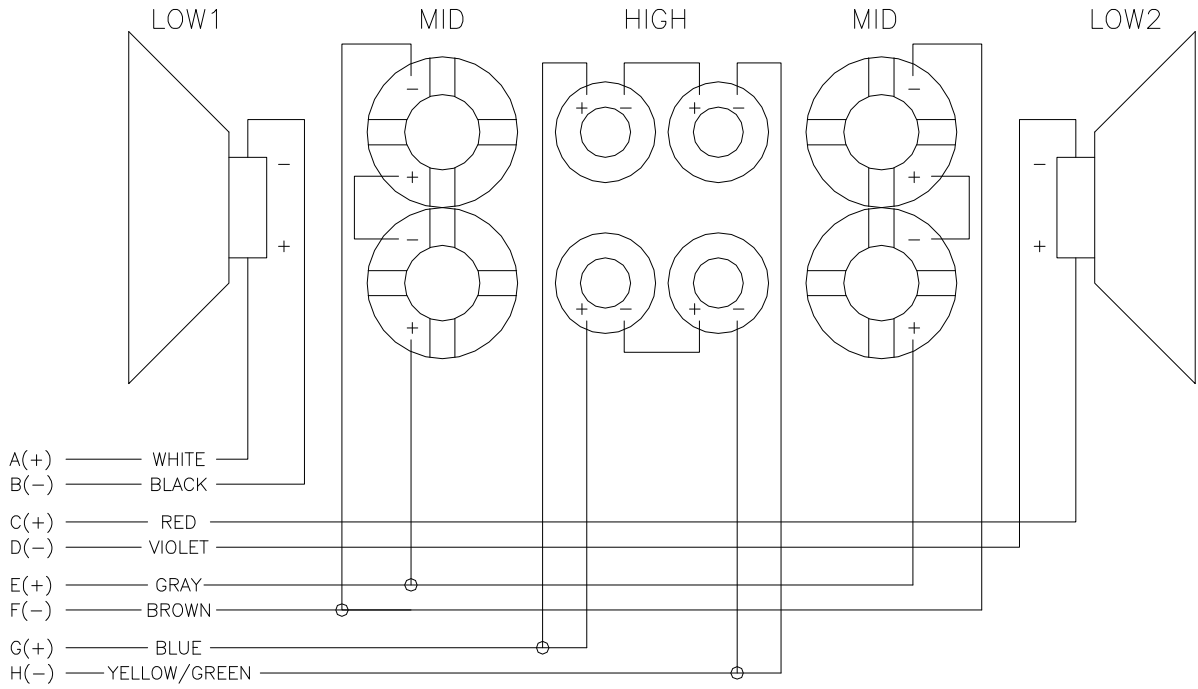

Figure 7 - Loudspeaker wiring diagram

The following is the diagram of the wiring between the connector and the amplifiers:

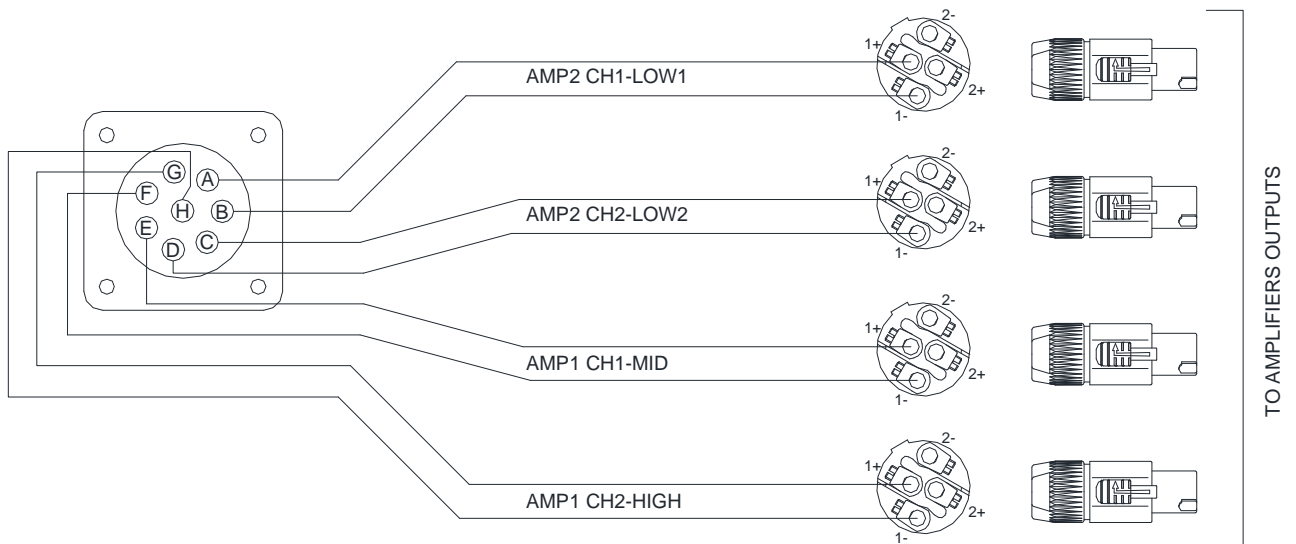

Figure 8 – Wiring between 8-pin connector and amp output connectors

To power the GTO, two T11 amplifiers are foreseen for three array elements connected in parallel:

- One channel for three HF sections (16 Ω) in parallel
 - 3 x 500 W AES = 1500 W AES (6000 W peak)
- One channel for three Mid sections (8 Ω) in parallel
 - 3 x 800 W AES = 2400 W AES (9600 W peak)
- One channel for three Low *half-sections* (1) (8 Ω) in parallel
 - 3 x 600 W AES = 1800 W AES (7200 W peak)
- One channel for three Low *half-sections* (2) (8 Ω) in parallel
 - 3 x 600 W AES = 1800 W AES (7200 W peak)

Combining T11 power amplifiers with three array elements connected in parallel ensures the best power transfer between the amps and the Line Array, also taking into consideration the cable connecting them. The following table shows the cable section required according to the length of the connection to ensure that the three GTO elements connected in parallel are powered correctly.

L line (m)	AWG cable	Cable sect. (mm ²)
25	13	2.63
30	12	3.31
35	11	4.15
40	11	4.15
45	10	5.27
50	10	5.27
60	9	6.62

A rack, containing six T11 power amplifiers, is conceived to power three groups of three enclosures connected in parallel: a total of nine enclosures for each rack.

Thanks to the use of an integrated DSP controller, these racks can be configured to power SUB, SIDE-FILL, DOWN-FILL and UP-FILL sections, as well as mixed sections. All this ensures the utmost installation flexibility. Each configuration has a corresponding preset, stored in the DSP controller or on another mass memory device.

The racks and GTOs are connected by means of a cable with eight-pin connectors. The panel of each GTO has a female connector for signal input and a male connector, in parallel with the former, for use as a bridge to feed the signal to the next element in the array.

Each rack is equipped with three eight-pin connectors, each of which is connected to two T11 amplifiers, as shown in the diagrams in Figure 6 and Figure 8.

Should it be necessary, for particular requirements, to power the systems with configurations other than those shown here, the power lost along the connection cable according to the section and length of the cable must be taken into consideration, using the following method:

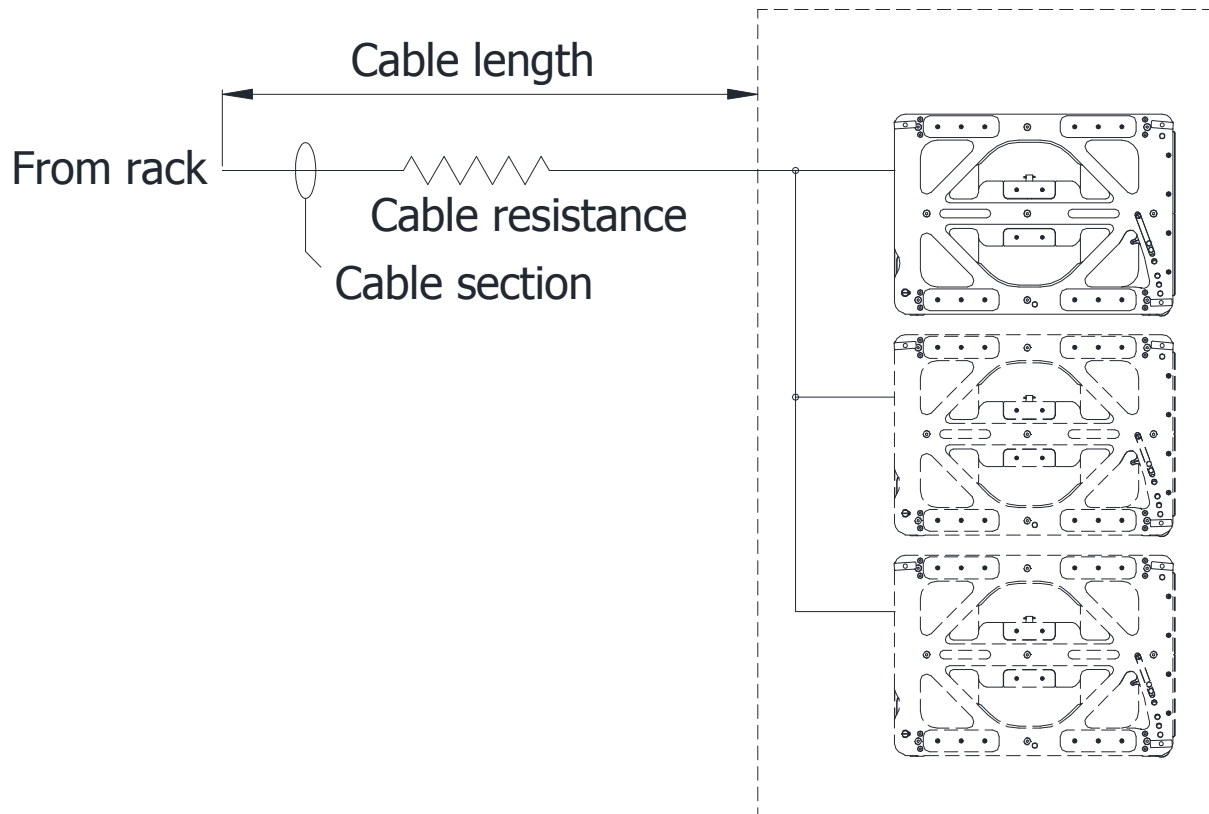

For each section, calculate the equivalent impedance (Z_{eq}) according to the number of enclosures (N) connected in parallel:

$$Z_{eq} = Z_{nom} / N$$

Z_{nom} HIGH	Z_{nom} MID	Z_{nom} LOW1	Z_{nom} LOW2
16	8	8	8

Then calculate the resistance of the cable using the following formula:

$$R = 2 \times 0.017 \times \text{Cable length (m)} / \text{Cable section (mm}^2\text{)}$$

Calculate the impedance of the total load (Z_{tot}) seen by the amplifier

$$Z_{tot} = Z_{eq} + R$$

At this point, having calculated Z_{eq} and R , it is possible to establish the division of the power between the load (High, Mid or Low section) and the connection cable with the following formula:

$$\text{Power on the load} = \text{Input power} \times Z_{eq} / (Z_{eq} + R)$$

$$\text{Power lost on the cable} = \text{Power on input} \times R / (Z_{eq} + R)$$

With the figures calculated, it is thus possible to assess the most suitable cable section, the amount of additional power that the amplifiers must provide in order for the load to reach the right power, the maximum length of the cable for a certain type of cable, etc...

When calculating the necessary power (required from the power amplifier), the actual load seen by amplifier must be taken into consideration, assessing its load curves. As an example, this graph shows the curve of the power fed out by the T11 against the load:

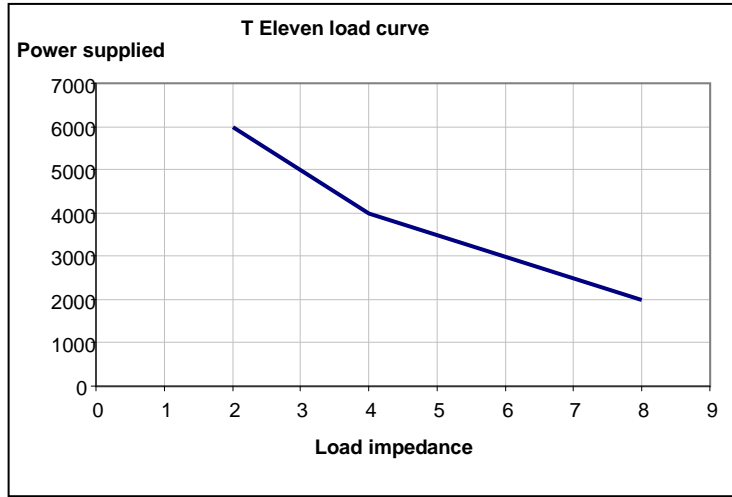

As is known, an excessively small cable section has a negative effect on the rated damping factor of the amplifier and, therefore, on the precision and response speed of the amplified system.

Assessing energy consumption

The assessment of energy consumption is necessary to establish the power required in the case of live events and permanent installations. When estimating consumption, it is advisable not to confuse the maximum power that can be provided by the amplifiers and/or is able to be handled by the sound reinforcement system with the power absorbed by the system over average periods of time. In fact, the music signal that powers an electro-acoustic system is completely different from the sine wave that powers an electric motor or a lamp. In the former case, there is a highly dynamic signal, with crest factors (the ratio between the peak and RMS value) that may be even more than 10 dB; in the latter (pure sinusoidal), the signal is constant for long periods and its crest factor is 3 dB. This means that even although a power amplifier can provide an RMS power as stated in its technical characteristics for medium periods of time, in actual fact it will have to work with much lower RMS levels (apart from short periods) and crest factors enabling to exploit the peak power level the amplifier can give to the utmost. In normal practice, it is customary to consider the consumption as being equivalent to 1/8 of the maximum rated power for a very dynamic music program (classical music, Jazz, Pop-Rock), and 1/4 of the rated power for more demanding signals (Heavy Metal, Hard-Rock). As a precautionary measure, the following table shows the consumption foreseen in the most demanding situations for a rack powering nine GTO with six T11 amplifiers:

Section	High	Mid	Low1	Low2	TOT:
Max consumption (W)	1200	1800	1400	1400	5800

To calculate the power supply necessary for a complete system, multiply the total shown in this table by the number of racks installed.

BLOCK DIAGRAMS

Installation configurations can vary considerably, according to the type of event for which each system must be used. The following pages show some examples of configurations of various sizes, in order to give a general balance of the necessary components, as well as the logistics of the connections between the racks and SUBs, MAIN, UP-FILL and DOWN-FILL systems. The diagrams shown are not the only possible set-ups; a system's correct dimensions must be established by the sound engineer according to specific requirements. The average ratio to consider between the subwoofers and the system is one subwoofer (LAB21-HS) for each GTO element. Subwoofers can be used in both standard and cardioid configuration. A cardioid configuration is used when it is necessary to reduce rear emission; for example, when the subs are aligned along the front of the stage indoors or in partially roofed venues where it is necessary to concentrate acoustic energy in the audience zone.

The following illustrations show the front and rear responses of two subs in cardioid configuration compared with the front and rear response of a single subwoofer. Note the high rejection of rear emission compared to front emission in the case of the cardioid configuration, as well as the effective addition on the front axis.

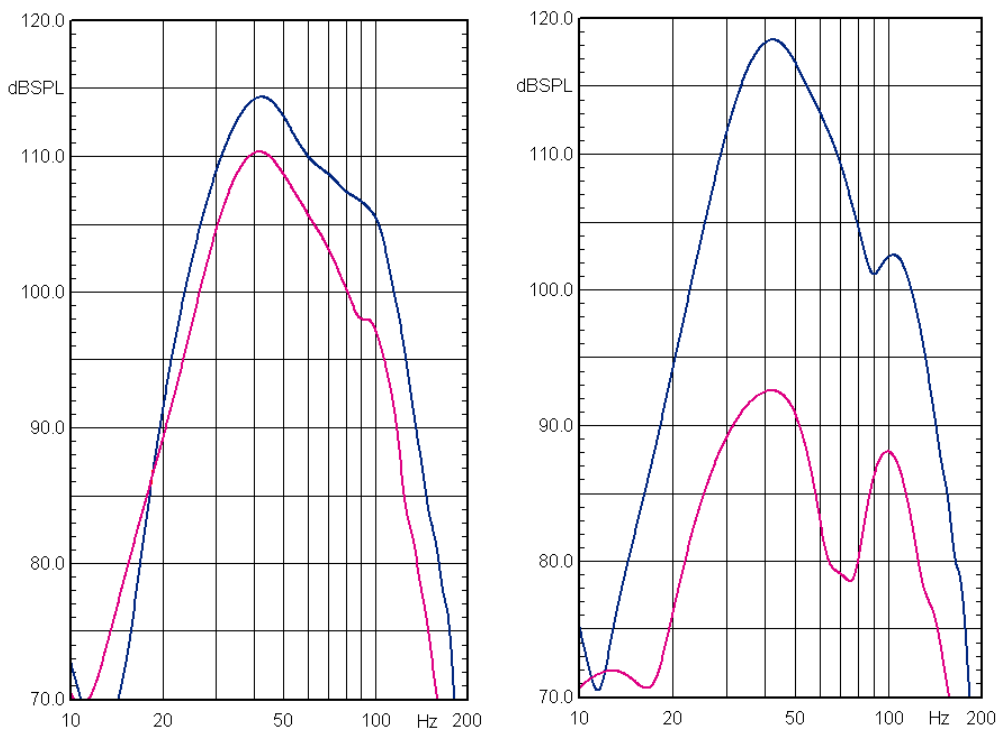

Figure 9 - Comparison between front (blue) and rear (magenta) emissions between a single subwoofer (left) and two subwoofers in "cardioid" configuration (right)

Some examples of typical systems cabled to racks follow:

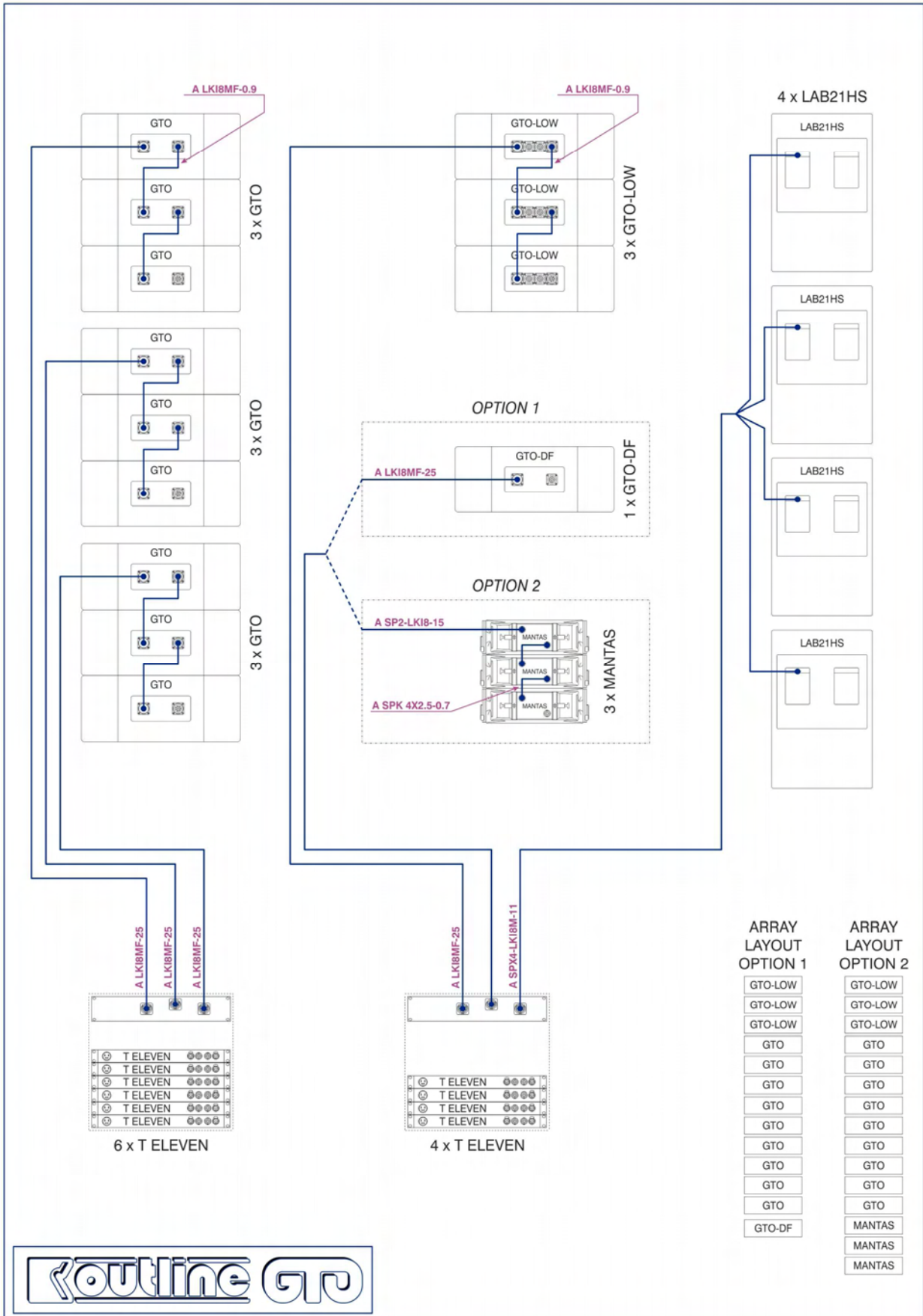

Figure 10 - 9 GTO / 1 GTO-DF or 3 MANTAS / 3 GTO-LOW / 4 LAB21 HS

**OUTLINE GTO LINE ARRAY
MANUAL FOR USE, MAINTENANCE, CONTROL & ELECTRO-ACOUSTIC INSTALLATION**

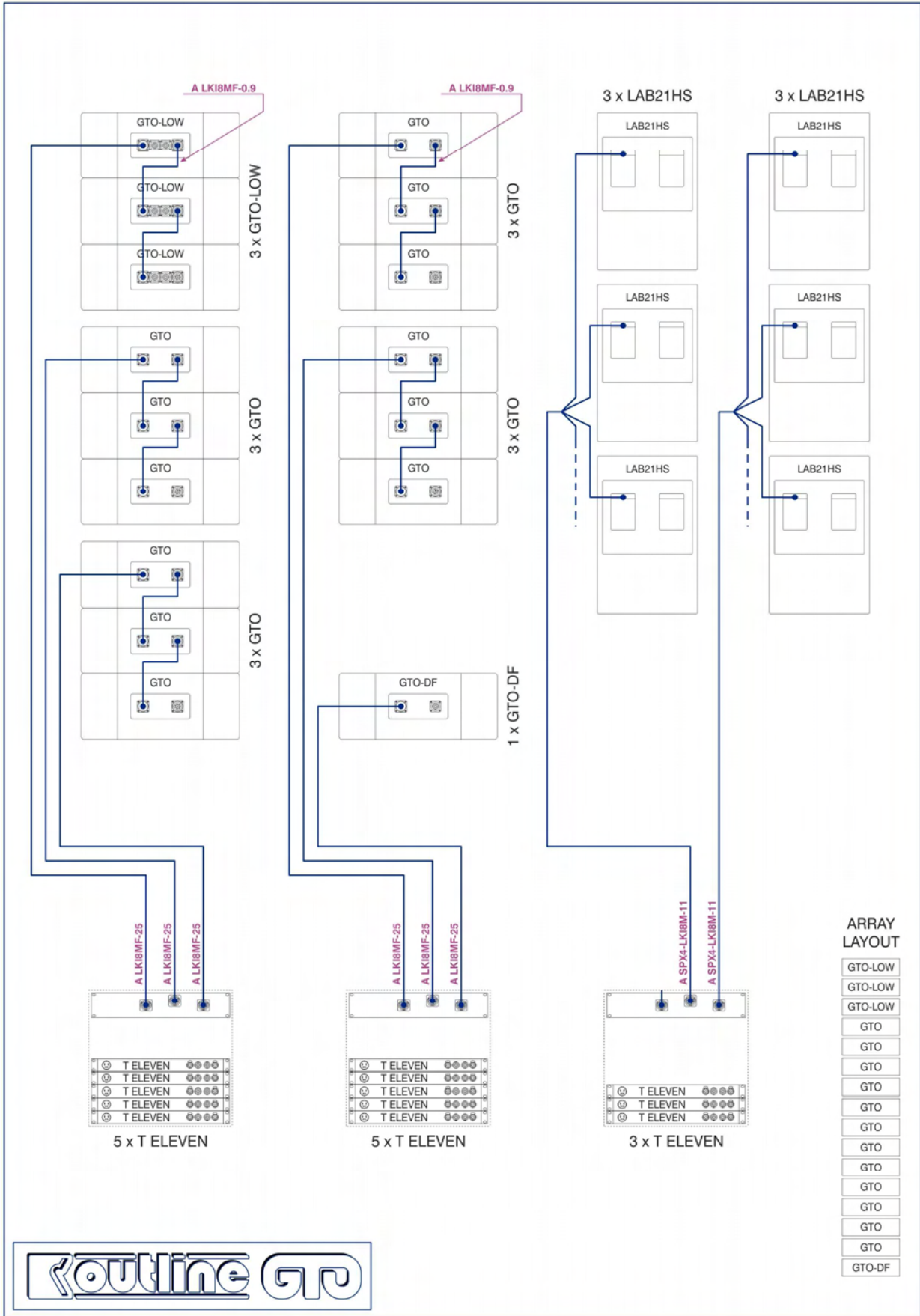

Figure 11 - 12 GTO / 1 GTO-DF / 3 GTO-LOW / 6 LAB21 HS

OUTLINE GTO LINE ARRAY
MANUAL FOR USE, MAINTENANCE, CONTROL & ELECTRO-ACOUSTIC INSTALLATION

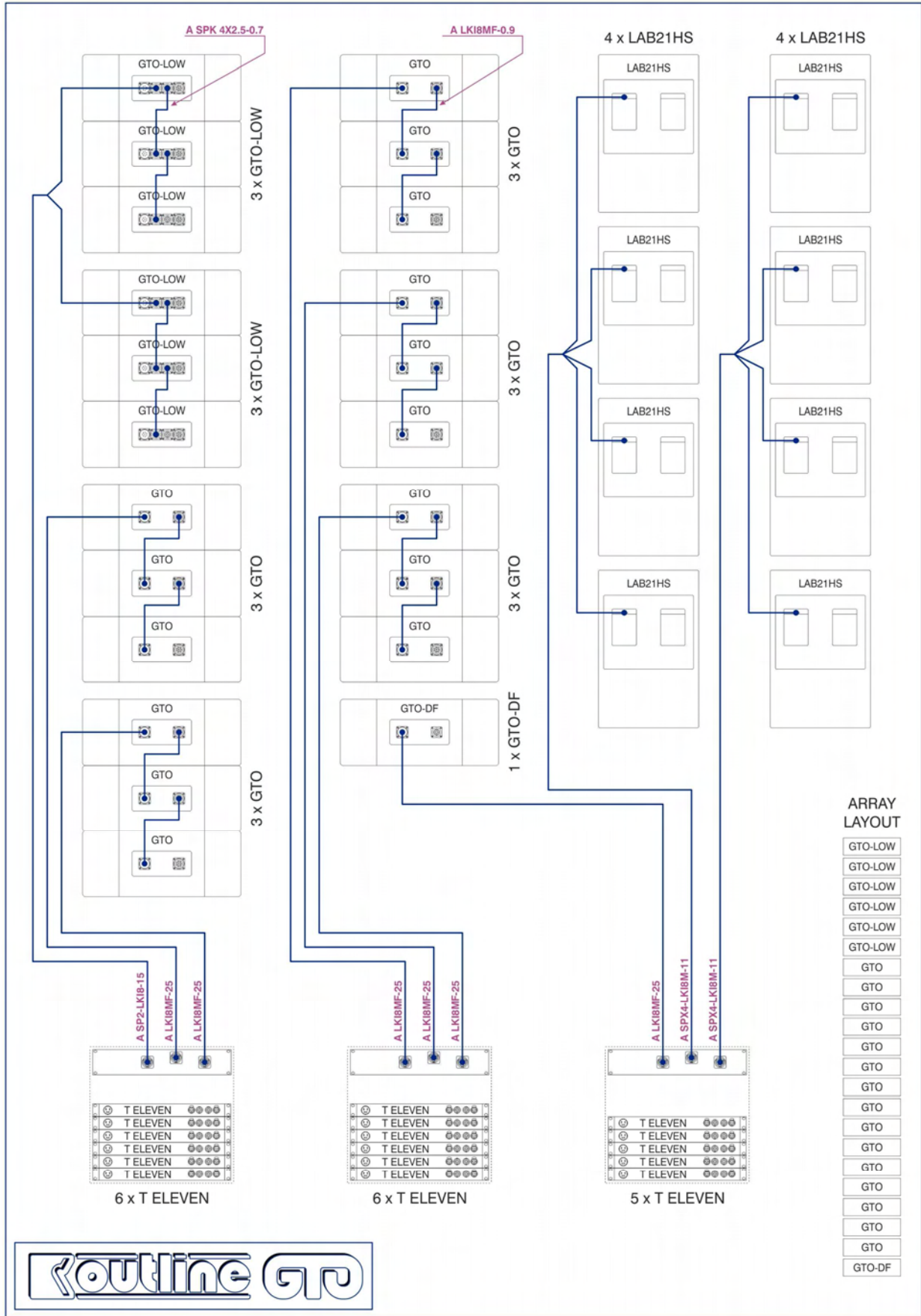

Figure 12 - 15 GTO / 1 GTO-DF / 6 GTO-LOW / 8 LAB21 HS

System regulation

A “Line Array” system is by its very nature geometrically configurable, mainly according to the area it will have to cover with its sound. The variability of the array’s dimension causes a modification of the radiation surface and therefore the acoustic impedance, as well as edge diffraction. This has a loading effect on the system’s overall response that begins from the mid frequencies and gradually increases toward the low frequencies. The resulting response must therefore be corrected with compensation filters in order to achieve the correct balance. The following illustrations show this effect for systems made up of 6, 9 and 15 enclosures. The first illustration of the series shows the behaviour of a single array element. The illustrations were obtained using Outline’s proprietary OPEN-ARRAY acoustic simulation software.

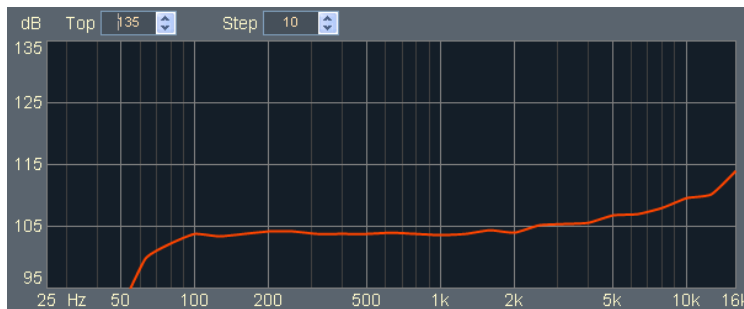

Figure 13 – 1 GTO, simulated on-axis response



Figure 14 – 6 GTO, simulated on-axis response



Figure 15 – 9 GTO, simulated on-axis response



Figure 16 – 15 GTO, simulated on-axis response

Technical data

Frequency response:	(-10 dB)	35 Hz – 18 kHz
	(+/-3 dB)	50 Hz – 18 kHz
Single section frequency band:	High	1 kHz – 18 kHz
	Mid	200 Hz – 1 kHz
	Low	35 Hz – 200 Hz
Average dispersion	Horizontal	90°
	Vertical	Depending on array configuration
Nominal Impedance	High	16 Ω
	Mid	8 Ω
	Low	2 x 8 Ω
Minimum Impedance	High	15.3 Ω
	Mid	6.8 Ω
	Low	2 x 6.5 Ω
Power Handling – AES	High	500 W
	Mid	800 W
	Low	1200 W
Power Handling – PEAK	High	2000 W
	Mid	3200 W
	Low	4800 W
Max SPL (calc.) – RMS	High	138 dB SPL
	Mid	134 dB SPL
	Low	131 dB SPL
Max SPL (calc.)– Peak (+6 dB)	High	144 dB SPL
	Mid	140 dB SPL
	Low	137 dB SPL
Max SPL 4 Enclosures (calc.)– Peak (+6 dB)*	High	150 dB SPL
	Mid	148 dB SPL
	Low	149 dB SPL
Connection		male/female 8-pole connector
Connection specifications	A	Low1 +
	B	Low1 -
	C	Low2 +
	D	Low2 -
	E	Mid +
	F	Mid -
	G	High +
	H	High -
Loudspeaker	High	4 x 3" diaphragm NdFeB compression driver loaded by two double V-coupled D.P.R.W.G.
	Mid	4 x 8" NdFeB partially horn loaded mid-woofer
	Low	2 x 15" hybrid band-pass loaded woofers
Weight – kg (lb)		96 (212)
Dimension – mm (")	Net	1126 x 460 x 655 (44.3 x 18.1 x 25.8)
	With pins inserted	1126 x 460 x 655 (44.3 x 18.1 x 25.8)
Max array dimensions (always check with OPENARRAY – Mechanics)		Up to 24 elements in STANDARD mode**

* Simulated at 20 m – referred to 1 m

** See USER'S MANUAL FOR MAINTENANCE, CONTROL AND INSTALLATION OF THE "OUTLINE GTO ARRAY" SYSTEM

Dimensions

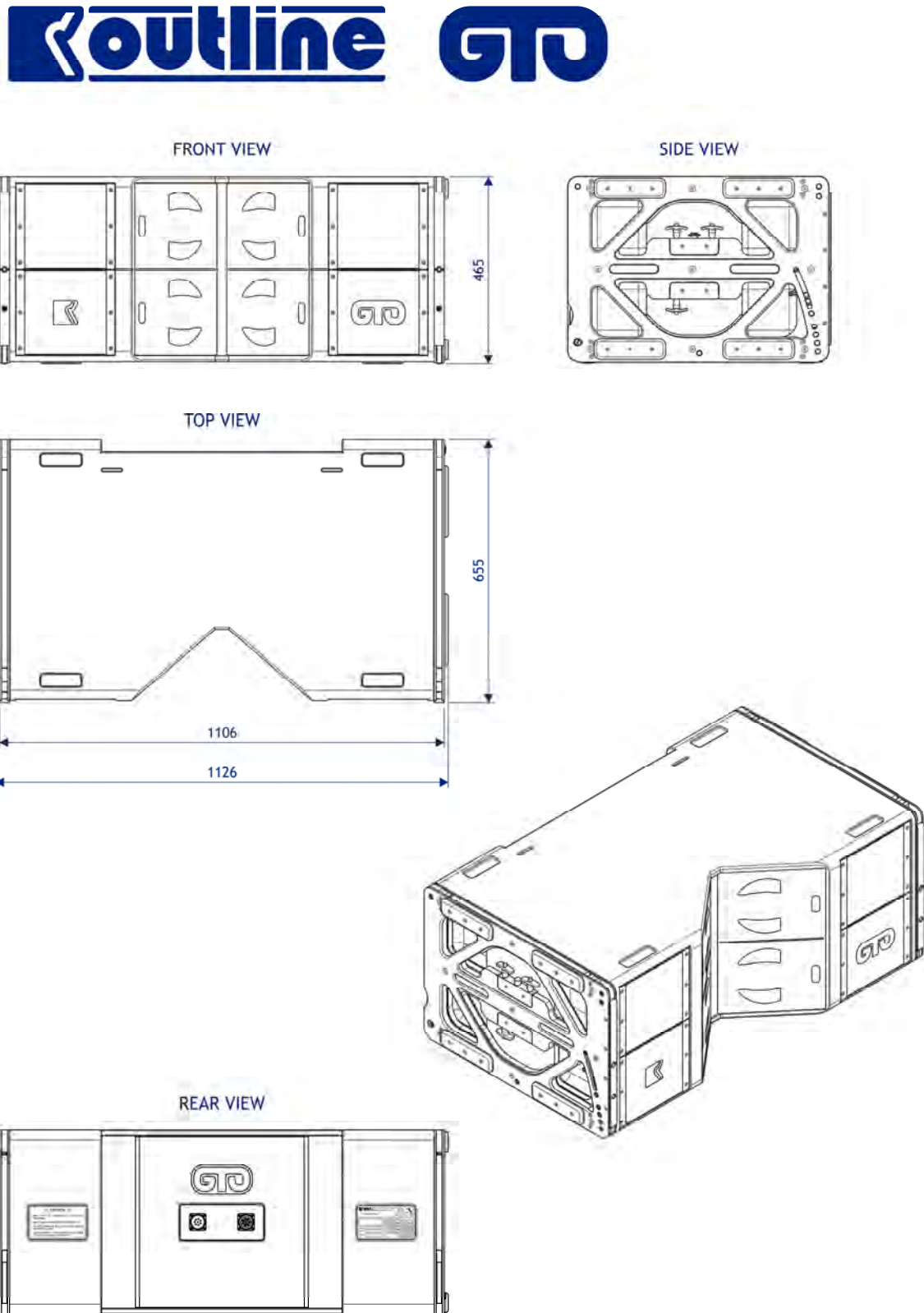

Figure 17 - Dimensions

APPENDIX 1

OpenArray – 3D simulation software

INTRODUCTION

OpenArray is proprietary Outline software for 3D simulation of electro-acoustic events. A particular feature of OpenArray is its ability to predict direct field sound pressure distribution resulting from the interaction of different sound sources, such as line array, sub and point source systems. The environment can be constructed directly in OpenArray by entering the planes and assigning the relative vertices of the 3D space. Alternatively, it is also possible to enter an environment in OpenArray using the import command of a standard OBJ or DXF file previously prepared (for example) with AUTOCAD 3D. To import this format (DXF), the environment to be imported must be designed using “3DFACE” entities. The direction in which the vertices of the 3DFACES are created (clockwise or counterclockwise) is unimportant.

By means of the Open Mechanic module, OpenArray also provides all the mechanical data necessary for installing the Line Array system, showing the impossibility of installation in the event of the load-bearing limits of the mechanical components being exceeded.

Workflow example for entering GTO

The typical workflow regarding the design of an event should be as follows:

1. Gather the documentation regarding the venue in which the event will be held (layout and dimensioned or scaled sections)
2. Acquire the information necessary for designing the sound reinforcement system (areas to be covered, characteristics of the venue, type of event, etc.)
3. Prepare a simplified design of the venue to be covered, at least as far as the parts mainly involved in the event are concerned (audience zones, stage, position of any orchestra, obstacles to be taken into consideration, etc...). In OpenArray, “GROUND” and “LISTEN” areas can exist. The former regard the structure, the latter the listening planes, i.e. the planes passing through the average height of the ears of the expected audience. To access the functions for creating and/or importing the environment, select “Audience” mode at the top left in the “Main commands” bar.

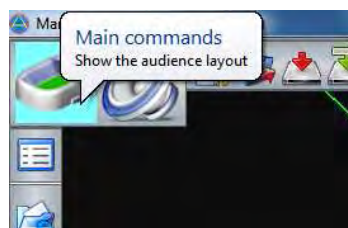

Figure 18 - Selecting Audience mode to enter planes

When creating the planes (“Add a new surface” command in the “Audience” box), it is possible to construct planes with four vertices (quadrilaterals) or three vertices (triangles).



Figure 19 – Entering a GROUND plane with 4 vertices

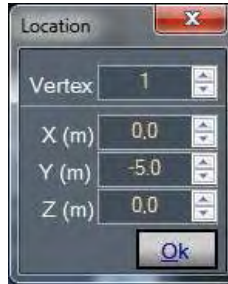

Figure 20 – Positioning the vertices on the XY plane (TOP VIEW)

The vertices can be moved by setting the coordinates (x, y, z) directly in the plane creation panel, or dragged with the mouse by selecting “Mouse functionality” mode in the main bar or pressing the F3 key.

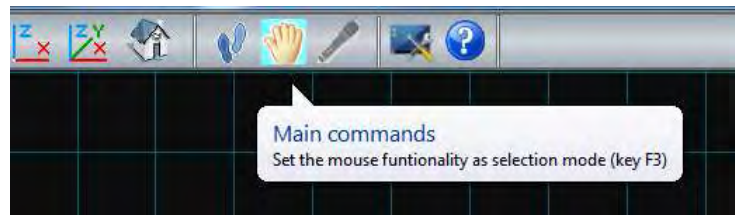

Figure 21 - Selecting mouse functionality

Movement can be made in all directions in the 3D space by choosing the plane on which to work by selecting “Top” or “Side”, again in the main bar (Main commands).

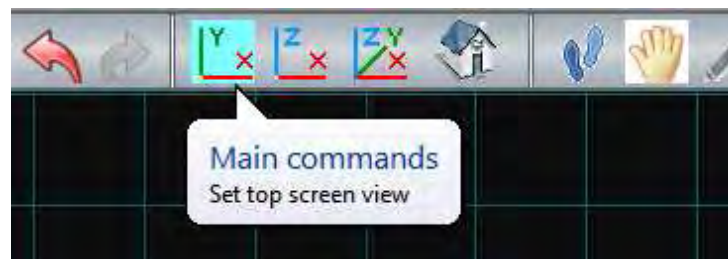

Figure 22 – Selecting the view (Top/Side/Perspective)

4. If available, it is possible to import the 3D design in DXF (3DFACE) or OBJ format. The following example regards importing a DXF file.

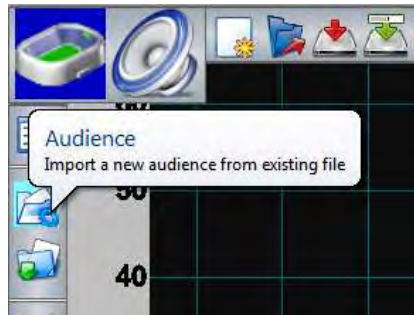

Figure 23 – Starting procedure for importing a DXF (or OBJ) file

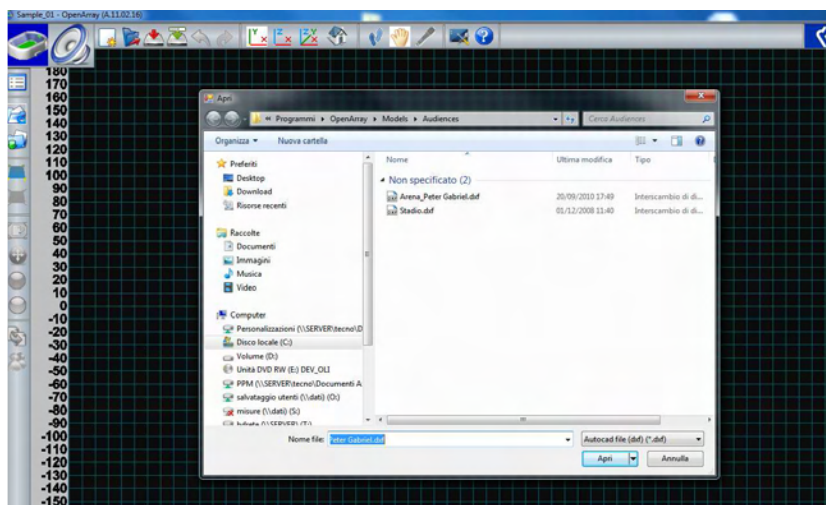

Figure 24 – Selecting the DXF file to be imported

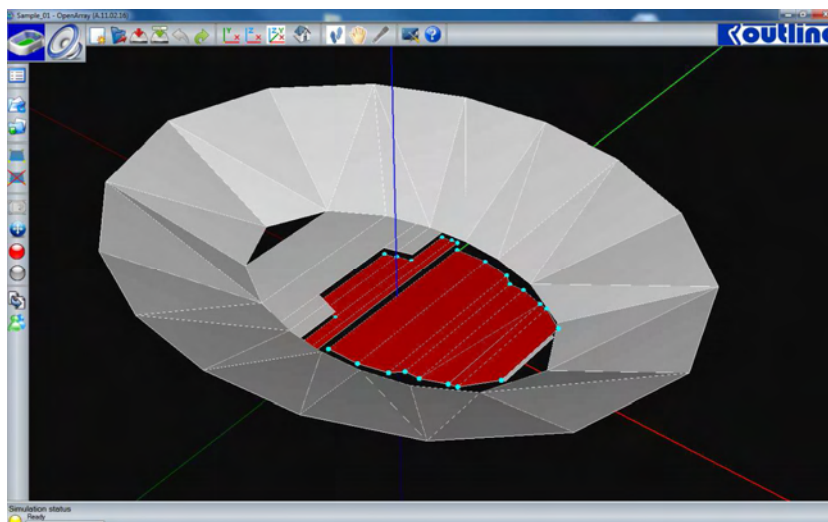

Figure 25 – Example of an imported DXF file

5. Creating the listening planes, necessary for enabling the simulation. As well as with the plane design function (“Add new surface” command in the “Audience” side bar), a Listening plane can also be created starting from an existing Ground plane and defining reciprocal distance (“Create the listening plane(s) from selection” command).

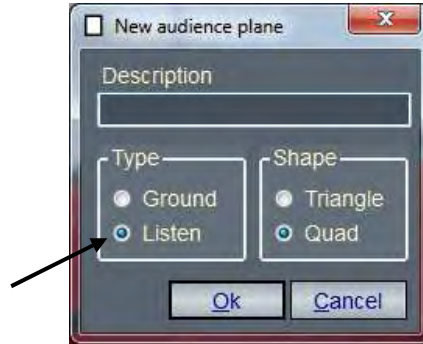

Figure 26 - Plane creation panel – “Listen” option



Figure 27 - Panel for creating a “Listening” plane starting from an existing « Ground » plane

6. After having designed or imported the audience and created the listening planes, all the loudspeaker systems that will form the entire sound reinforcement system must be entered. It is advisable to proceed by zone, individually checking the behaviour of each system involved. Commands regarding the loudspeaker systems are accessed by clicking on the loudspeaker icon at the top left in the “Main commands” bar. A panel regarding simulation settings immediately appears.

Then, using the “Add a new speaker system (array/point source)” command in the “Speakers system” bar, the type of system required - Line array, Sub or Wide range (Point source) - can be entered.

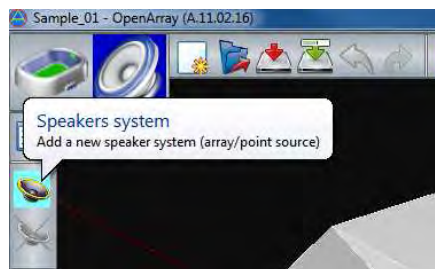

Figure 28 – “Add a new speaker system” Command

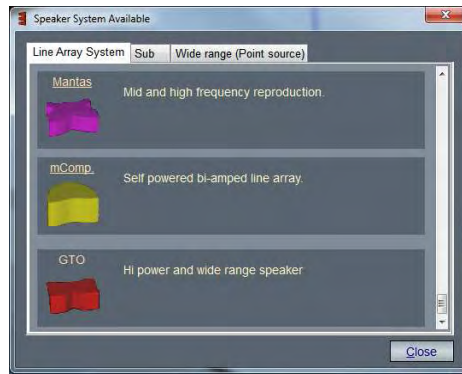

Figure 29 – Panel for entering loudspeaker systems

7. We shall now cover the entry of a GTO Array with a mirrored copy. For its creation, the following forms are available:
 - a. “System” form regarding the main options of the system chosen:
 - i. “Main” Section with options for:
 1. Num: number of GTO elements in the array
 2. Setup: setup file of the DSP processor to take into consideration in the simulation
 3. Main Frame: front or rear overhang of the main frame.



Figure 30 - Panel for entering GTO - System/Main form

- ii. “Down-fill” Section regarding the type of down-fill system to be used with the main GTO array:
 1. Down Frame: type of accessory for the down-fill
 2. Type: type of element (Butterfly Hi-Pack or Mantas) to add as a down-fill system
 3. Num: number of down-fill elements
 4. Setup: DSP setup to take into consideration in the simulation



Figure 31 – Panel for entering the GTO - System/Down-fill form

- iii. “Mirroring” command for the mirrored duplication of the newly entered array, with a choice of the axis

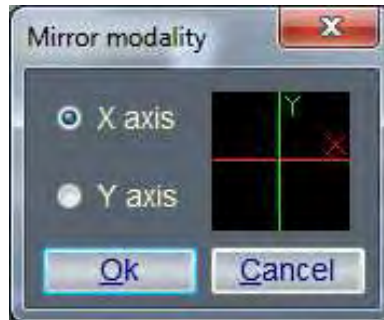

Figure 32 - Panel for entering GTO – “Mirroring” section

- b. “Location” form regarding the position of the system:
 - i. Location: X, Y and Z coordinates of the array entry point, which corresponds to the first element.
 - ii. Rotation axes (deg.): aiming angle of the array upwards or downwards (rotating round Y) and in a horizontal direction (azimuth, rotating round Z).

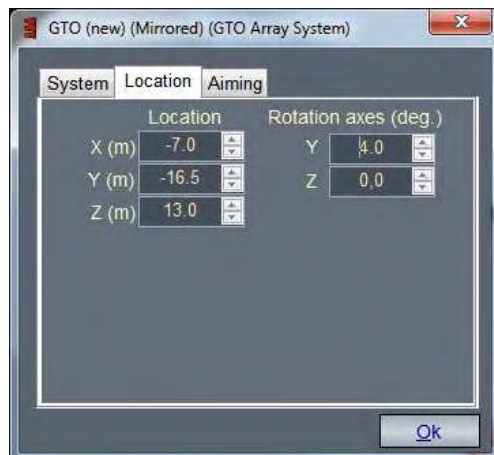

Figure 33 - Panel for entering GTO - Location form

- c. "Aiming" form regarding the aiming of the array elements [adjustment of the (splay) angle between the enclosures]. Aiming can be done manually, by setting the splay angle of the element selected in the table in relation to the previous element. The "All" option enables to assign the same angle set to all the elements of the array. For automatic aiming proceed as follows:
- Frame the array to be aimed and the zone to be covered with the navigation instruments
 - Aim the first element (at the top) at the highest point of the zone to be covered ("Location" form)
 - Press the "Auto" key in the "Aiming" form
 - Set the "Ending angle" to obtain the required coverage
 - Press "OK"

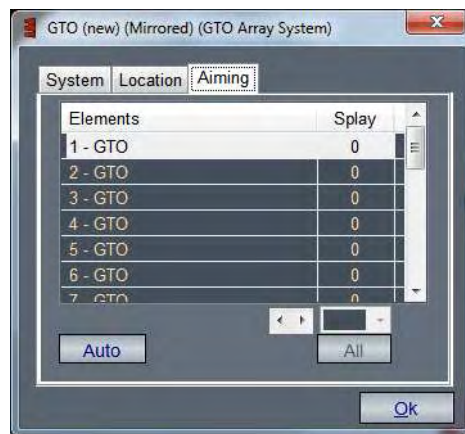

Figure 34 - AIMING form

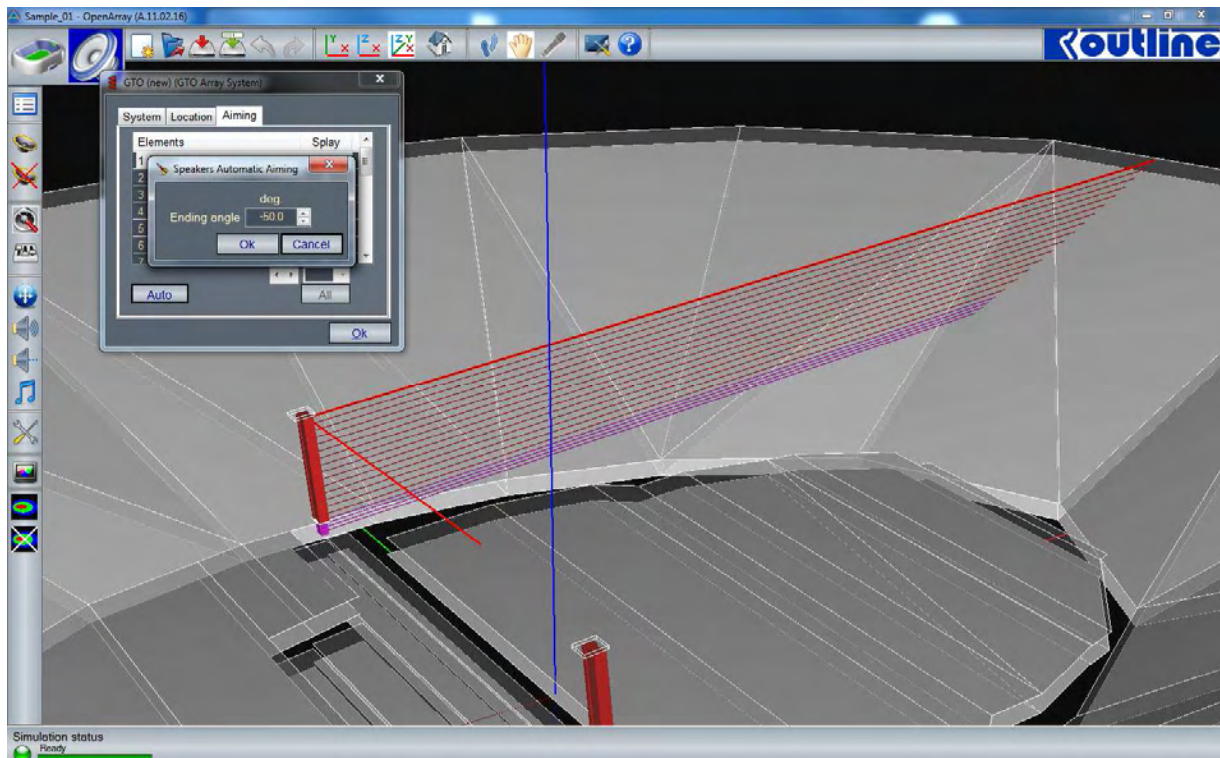

Figure 35 - Automatic aiming – settings

- After having automatically aimed the GTO array, it is necessary to manually aim the Mantas down-fill array, in order to obtain the correct coverage. If necessary, it is possible to automatically aim the GTOs without losing down-fill array aiming data.

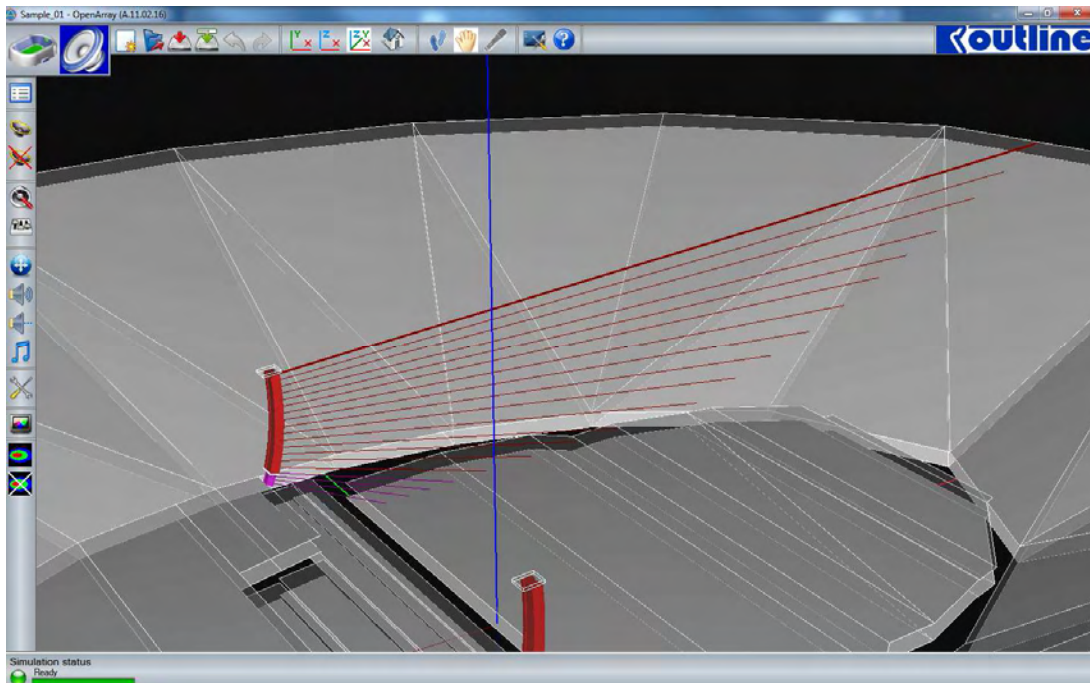

Figure 36- Automatic aiming – result

- After entering a GTO array with an under-hung Mantas down-fill array, it is possible to enter other sound sources, for example a series of subs in front of the stage, or an array of Butterfly for side-fill. Proceed as with the GTO array just entered.

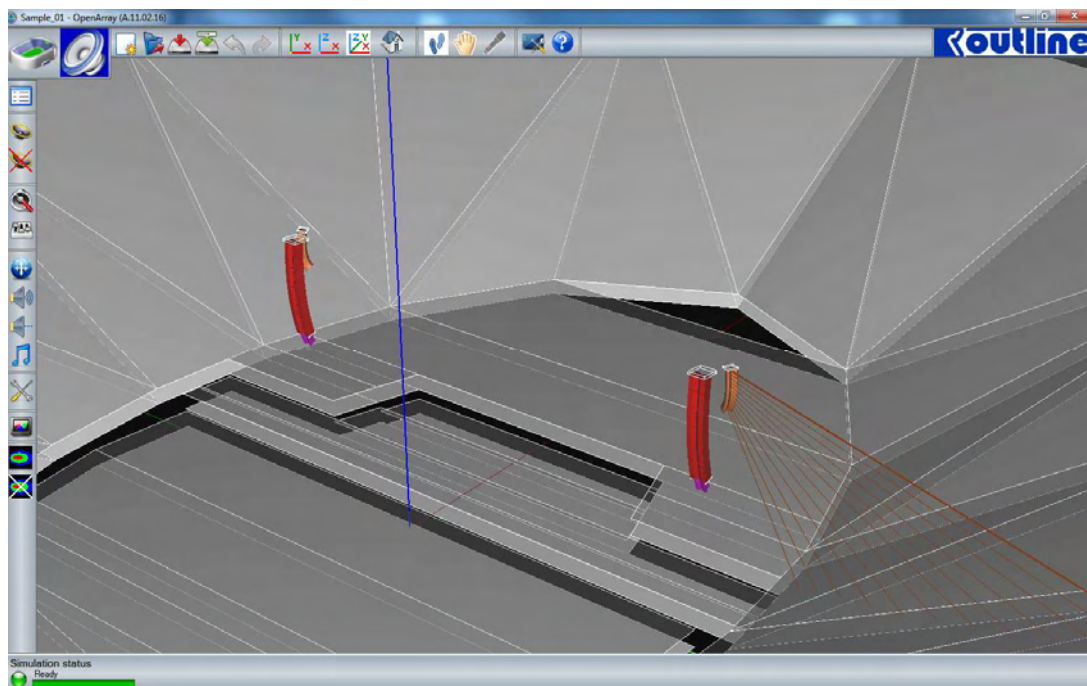

Figure 37 – Entering a side-fill array

10. After entering and configuring all the components of the sound reinforcement system, when “Show” is pressed in the “Simulation” box at the top right, the result of the simulation will be displayed.

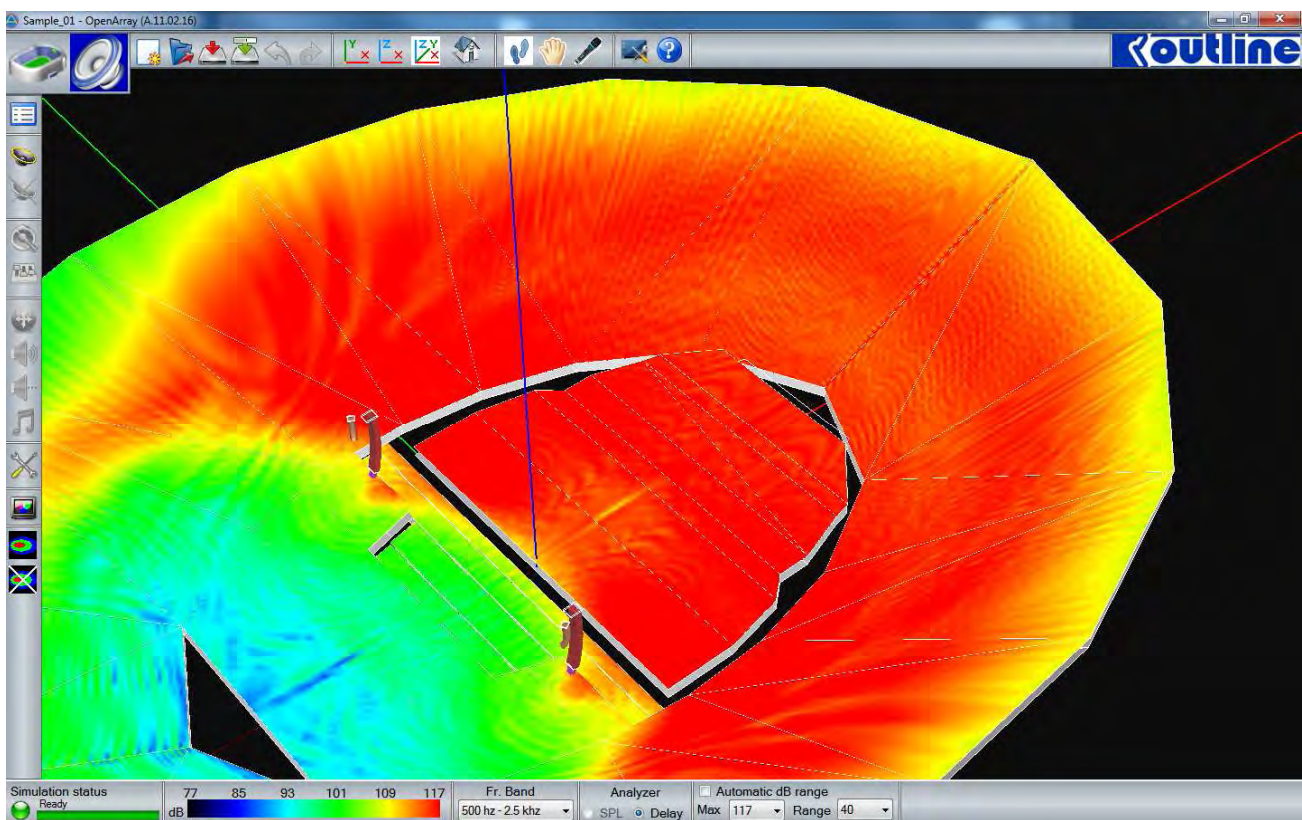
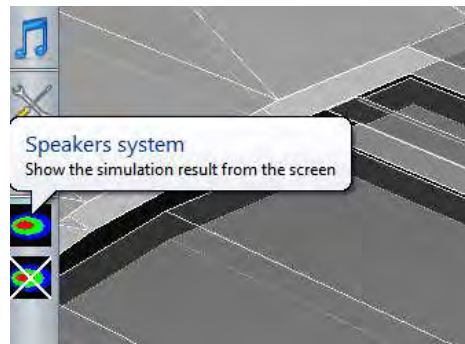

Figure 38 – Result of the simulation

11. At this point, it is possible to work on the system, modifying the position of the entire array and splay angles, to obtain the most even coverage possible. To do this, it is advisable to view the result of the simulation on average frequency bands (“Set the simulation parameters” command, “Speaker system” bar) and to narrow the range of decibels displayed. It is advisable to choose the bands according to the following diagram and a suitable display range. It is best to adopt display standards to be kept constant through time, to avoid errors of assessment due to display differences.

Freq. Band	DESCRIPTION
25 Hz – 100 Hz	Low frequencies.
100 Hz – 1 kHz	A great deal of the fundamental frequencies of vocals and almost all instruments are concentrated in this zone.
1 kHz – 5 kHz	Frequencies between mid and mid-high, very important for speech intelligibility and timbre definition
5 kHz – 16 kHz	Mid-high and high, decisive for understanding musical details.

Table 1 - Bands suggested for OpenArray

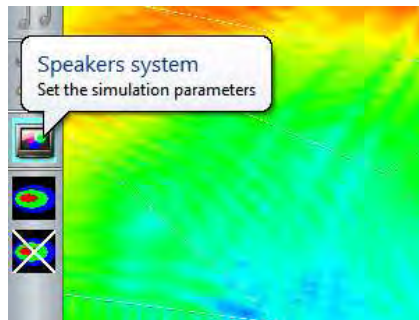

Figure 39 – Command for choosing simulation parameters

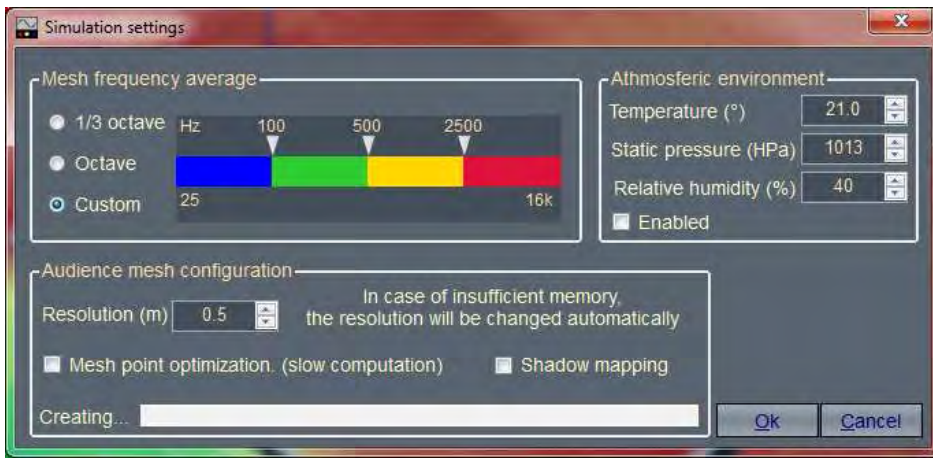

Figure 40 – Panel for setting frequency bands

OpenArray also provides a “Probe” utility for simulation analysis after processing. Pressing function key F4 or clicking in the icon “Set the mouse functionality as probe mode (key F4)” in the “Main command” bar,

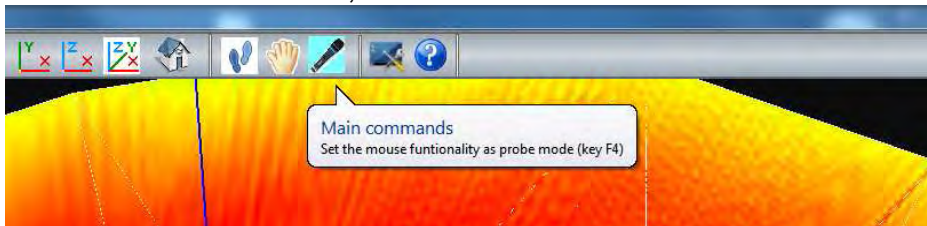
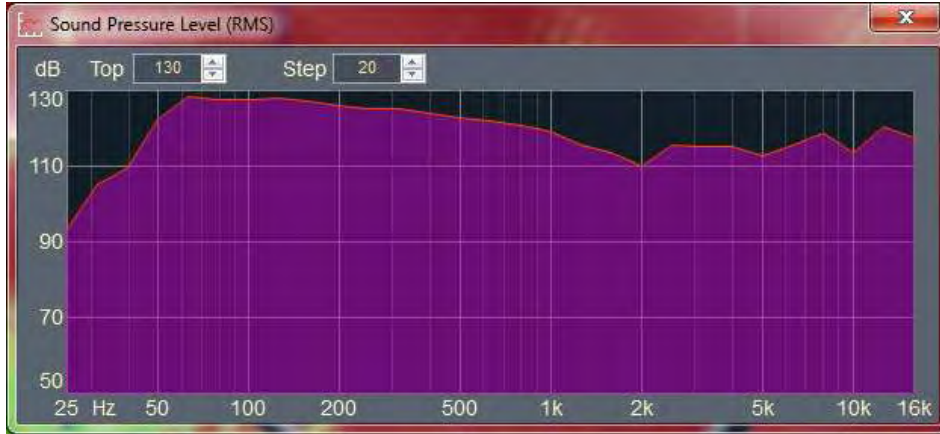

Figure 41 - PROBE Command

the “Probe” function will be enabled, allowing:

1. Analysis of the SPL response curve in any given point (only if the 1/3 octave analysis is enabled in the “Simulation setting” panel by pressing “Set” in the “Simulation” box)



2. Analysis of the arrival time of the various systems for correct time alignment of the various sound sources, very useful for aligning Side fills or Subs with the Main system, or “Delay” systems, for maintaining the sound image over very long distances.

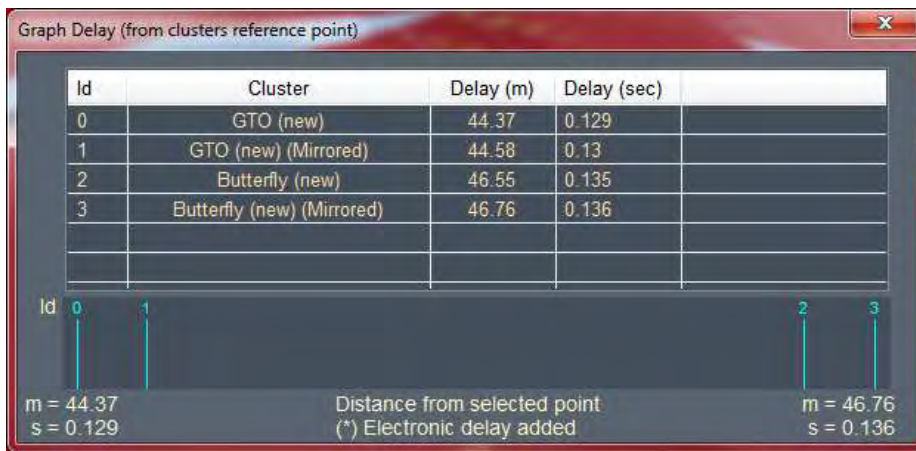

The choice of the type of analysis to be carried out (Delay or SPL) is made using the “Analyzer” panel in the bottom bar.

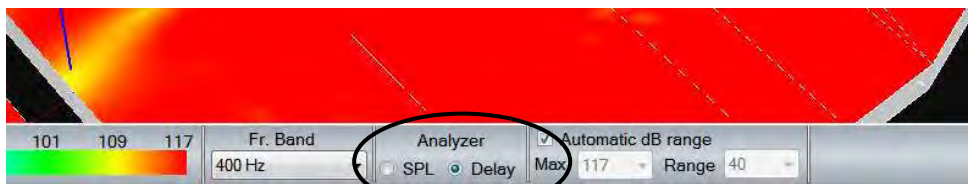

Open Mechanics

The final stage of the work flow consists in checking the feasibility of the project from a mechanical point of view, as well the preparation of the documentation necessary for the installation of the system designed. All this is possible by using the “Open mechanics” function, which, as can be seen from the following illustrations, provides all the data necessary for the check and shows if stress values are below permitted limits. If this is not the case, a message will appear, advising that these limits have been exceeded. Consequently, in these cases, the necessary changes must be made in order for the system to come within permitted limits. **THE INSTALLATION WILL ONLY BE POSSIBLE IF THE MECHANICAL CHECK WITH “OPEN MECHANICS” HAS GIVEN A POSITIVE RESULT.**

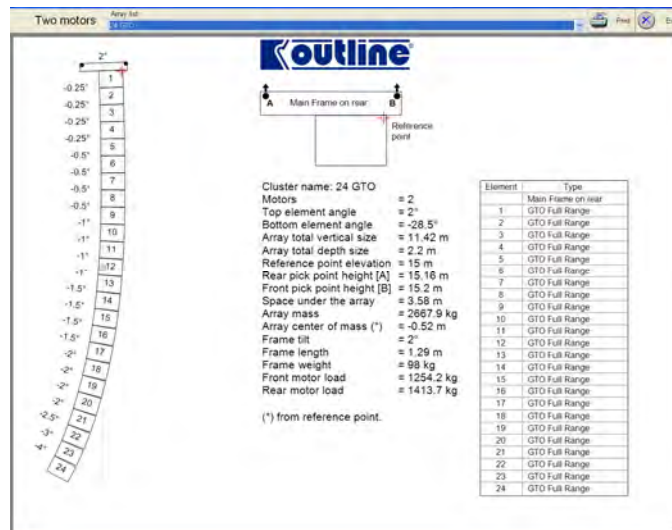

Figure 42 - Mechanical check: installation possible

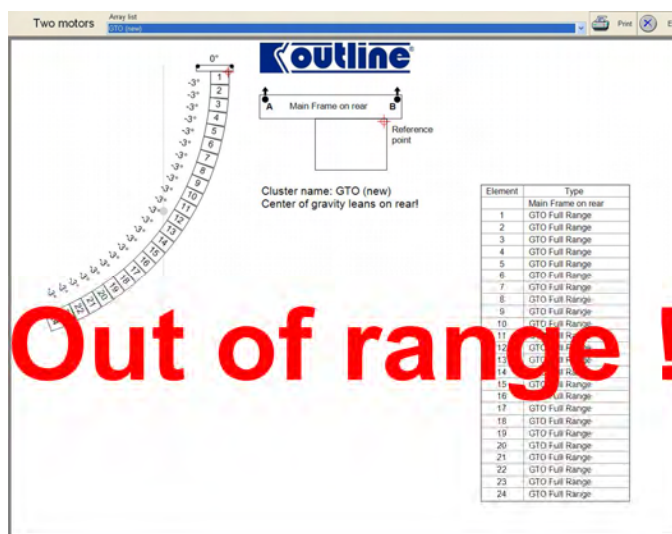
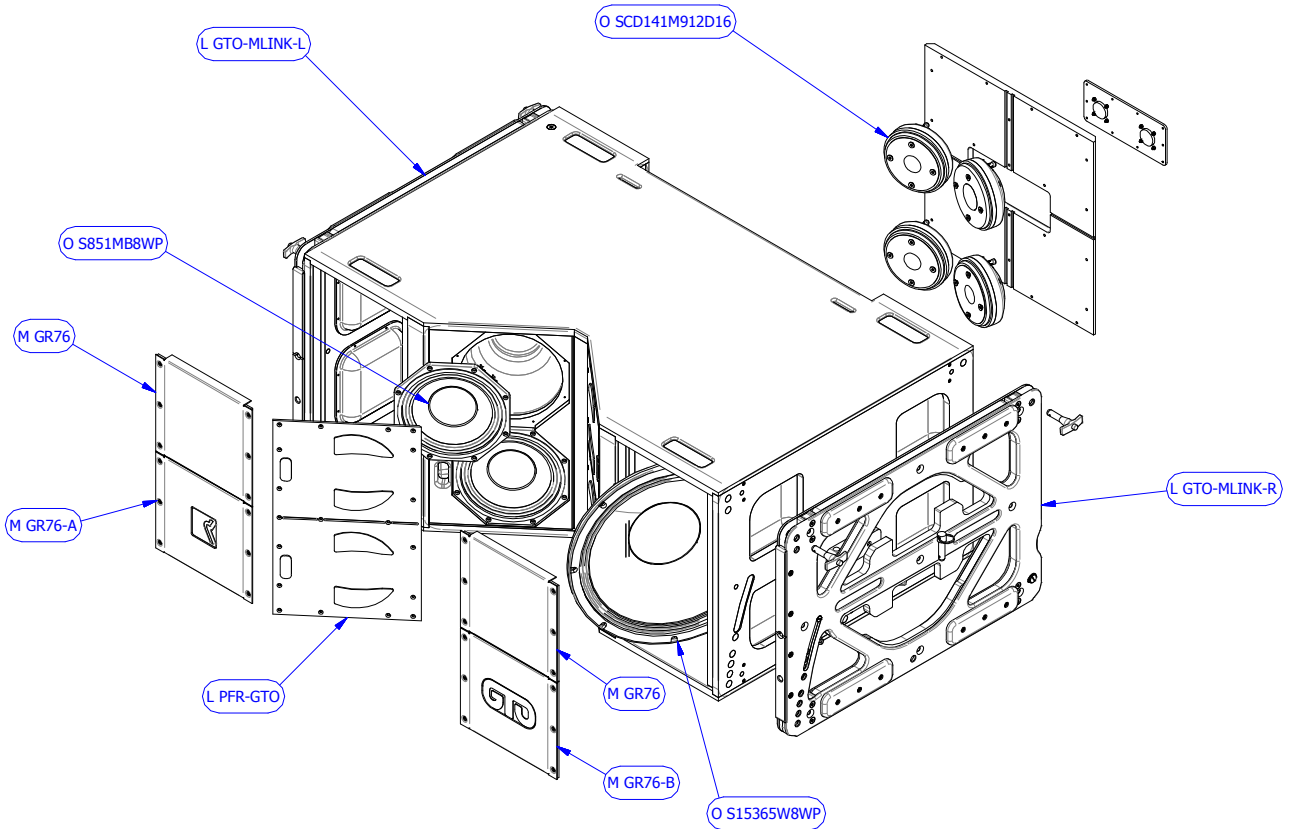

Figure 43 - Mechanical check: installation not possible

APPENDIX 2

Inspection, maintenance and repair work

Any maintenance and/or repair work on the product must be carried out by qualified staff. The following is an exploded diagram of the main parts that could be necessary for simple work with the code numbers for ordering spare parts



The code numbers of the loudspeakers and relative recone kits are shown in the following table:

SECTION	HIGH	MID	LOW
Driver Code	O SCDM912CFF	O S851MB8WP	O S15365W8WP
Recone Kit Code	O KCDM912CFF	O K851MB8WP	O K15365W8WP

Complete spare parts list:

For particular problems in which work is required on any part of the product, the following are complete exploded diagrams of the parts:

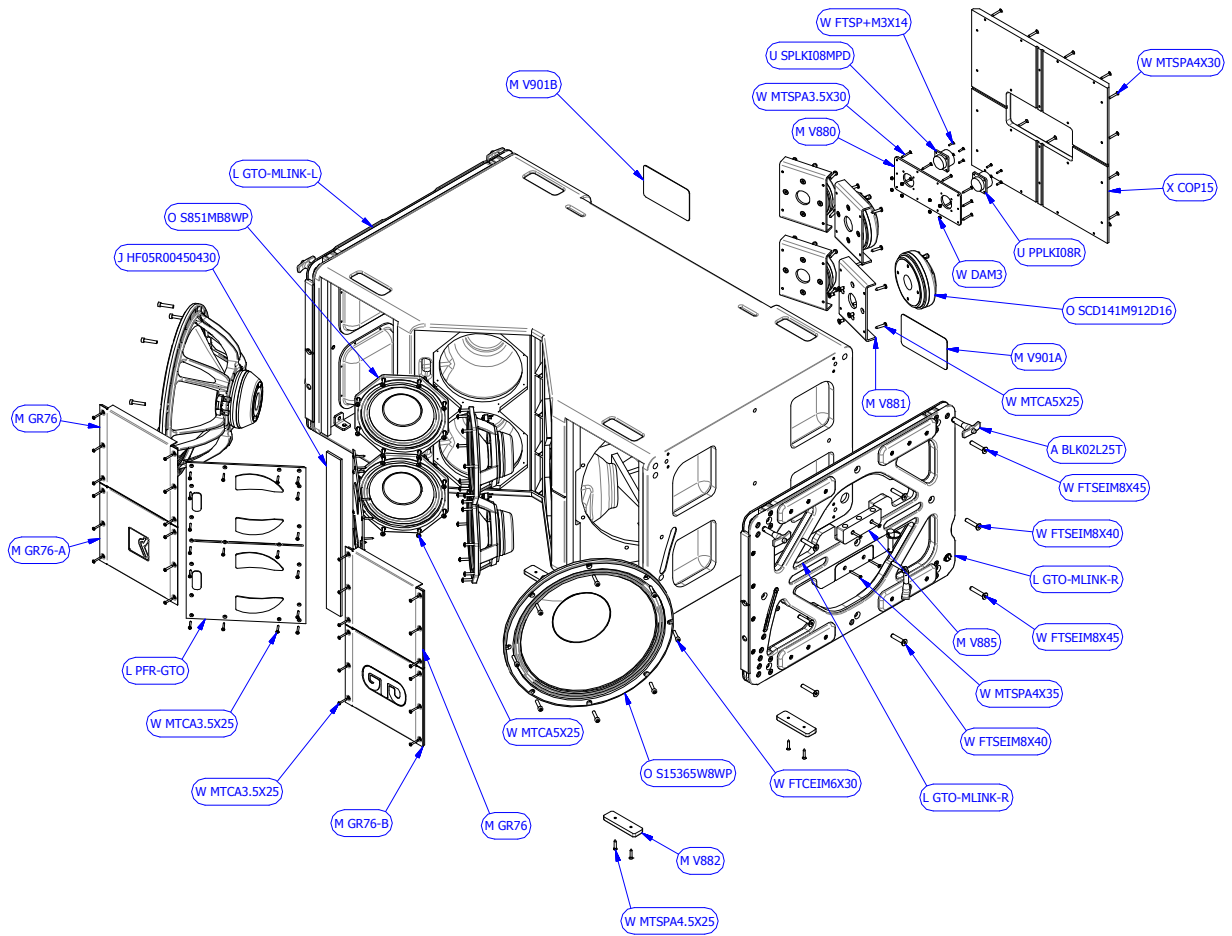

Figure 44 - Complete spare parts list

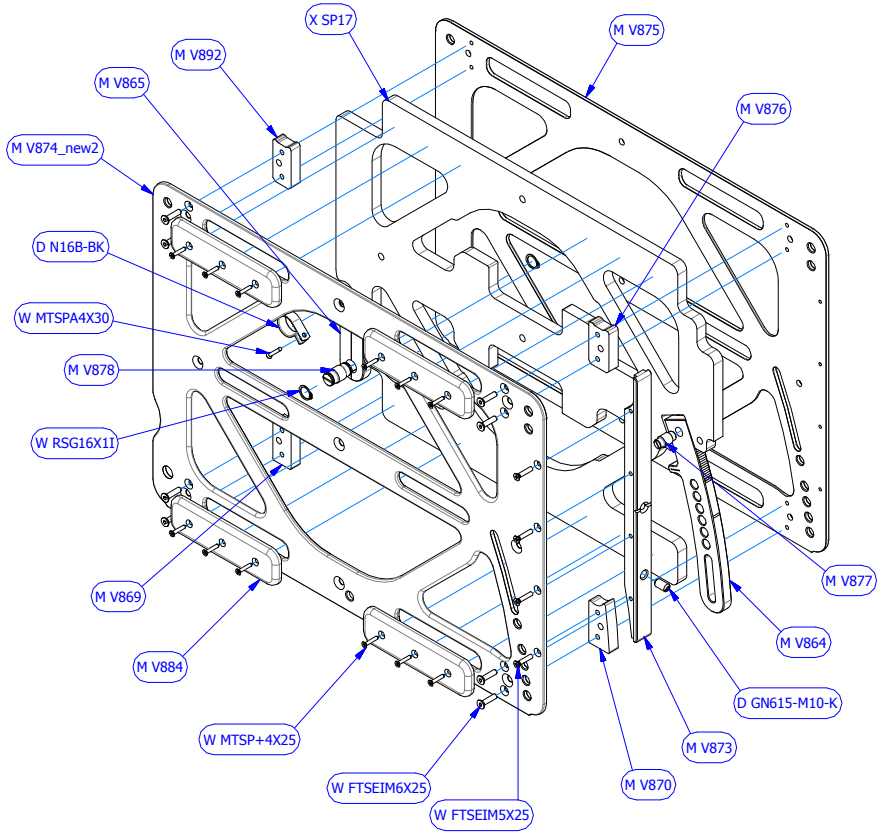

Figure 45 – Left-hand side mechanical spare parts list

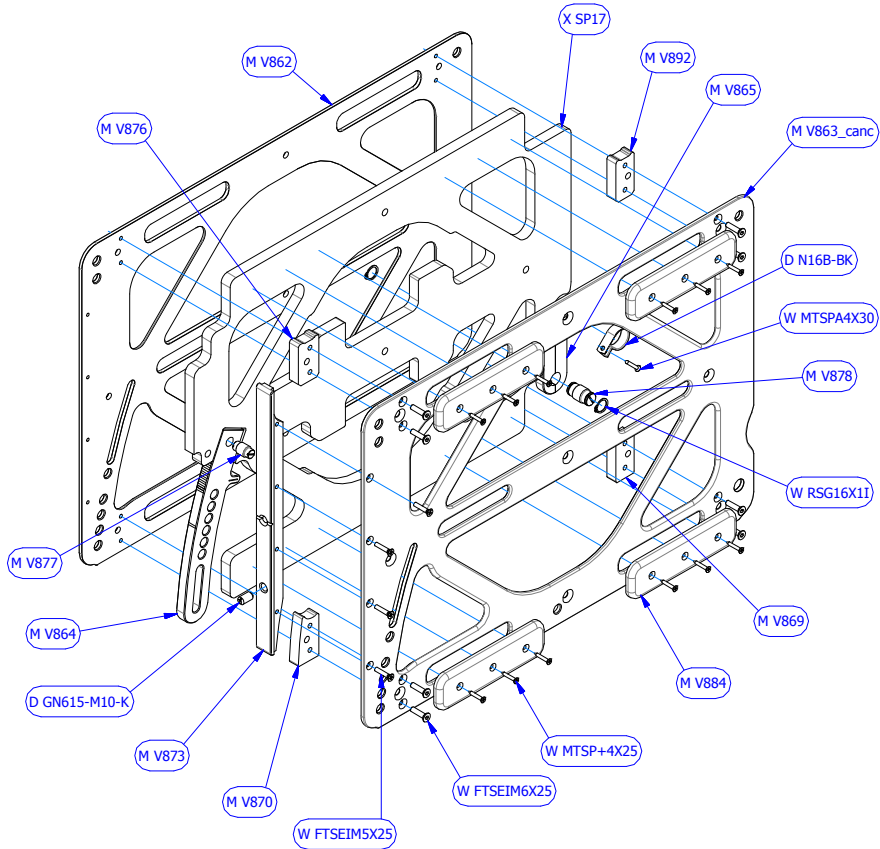

Figure 46 – Right-hand side mechanical spare parts service

APPENDIX 3

Calculating the parameters for positioning subwoofers in a “cardioid” configuration - Theory

Let's suppose that we have two identical omnidirectional sound sources and we are sufficiently far from them. The easiest way to create cardioid dispersion, for any given frequency, which we shall call “centre frequency”, is as follows:

1. position the two sources in such a way that there is a distance equal to a quarter of the wavelength of the centre frequency between them;
2. delay the rear source by a time equivalent to the distance between the two sources;
3. invert the phase of the rear sub.

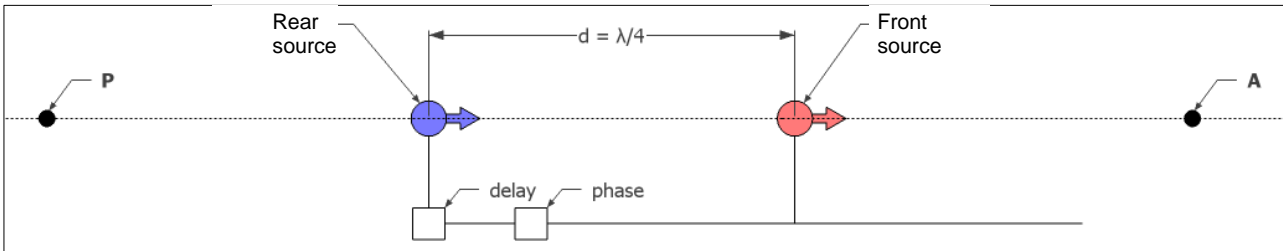

In this way, behind (point **P**), we have perfect cancellation at all frequencies and in front (point **A**), the addition of 6 dB at the centre frequency, cancellation at double this, then addition at triple and so on. The following graph enables to see this effect: for calculation, we used a central frequency of 50 Hz and cancellations can be seen at 100 and 200 Hz and additions at 50 and 150 Hz. It can be seen how the response curve behind is not visible, as there is total attenuation ($-\infty$ 8 dB) for all frequencies.

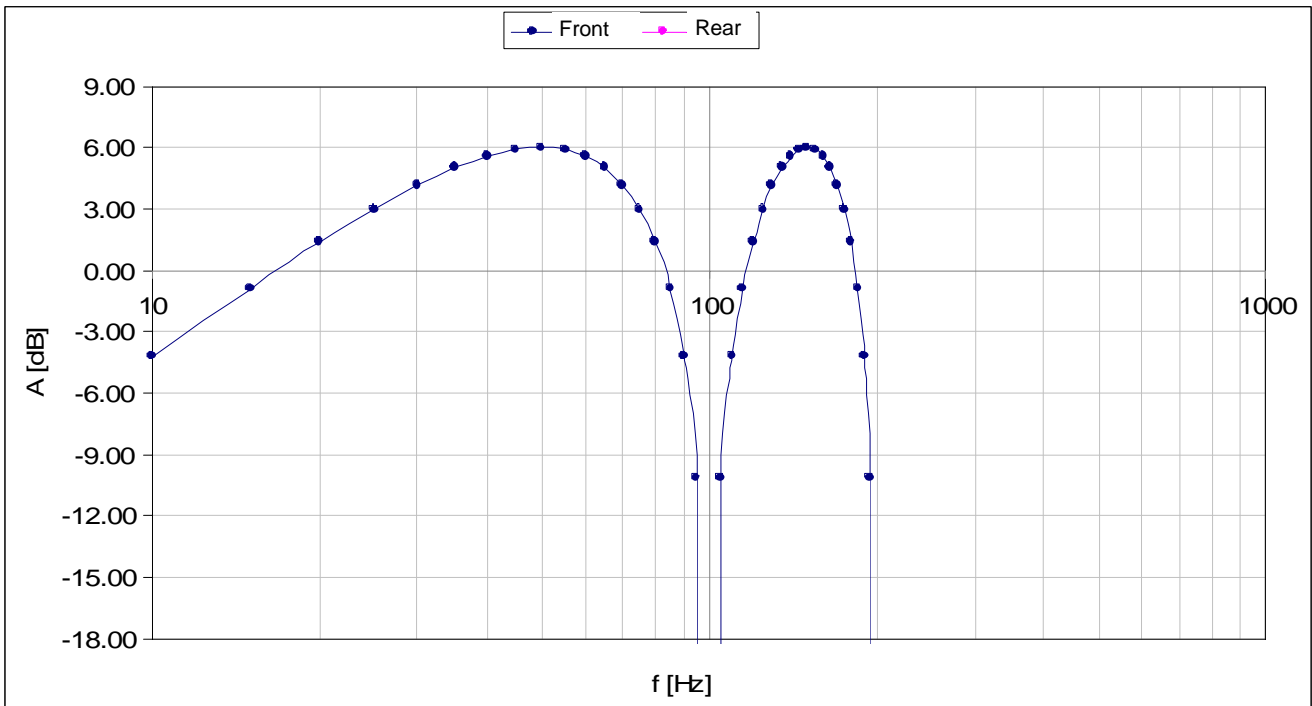

Cardioid configurations therefore enable to have:

- perfect cancellation of all frequencies behind the sources;
- addition in front within an interval of approximately an octave and a half.

The following graph shows the theoretical polar plot of the reduction at various frequencies between 20 Hz and 100 Hz. It can be seen how at 100 Hz there is cancellation in front and addition at the sides.

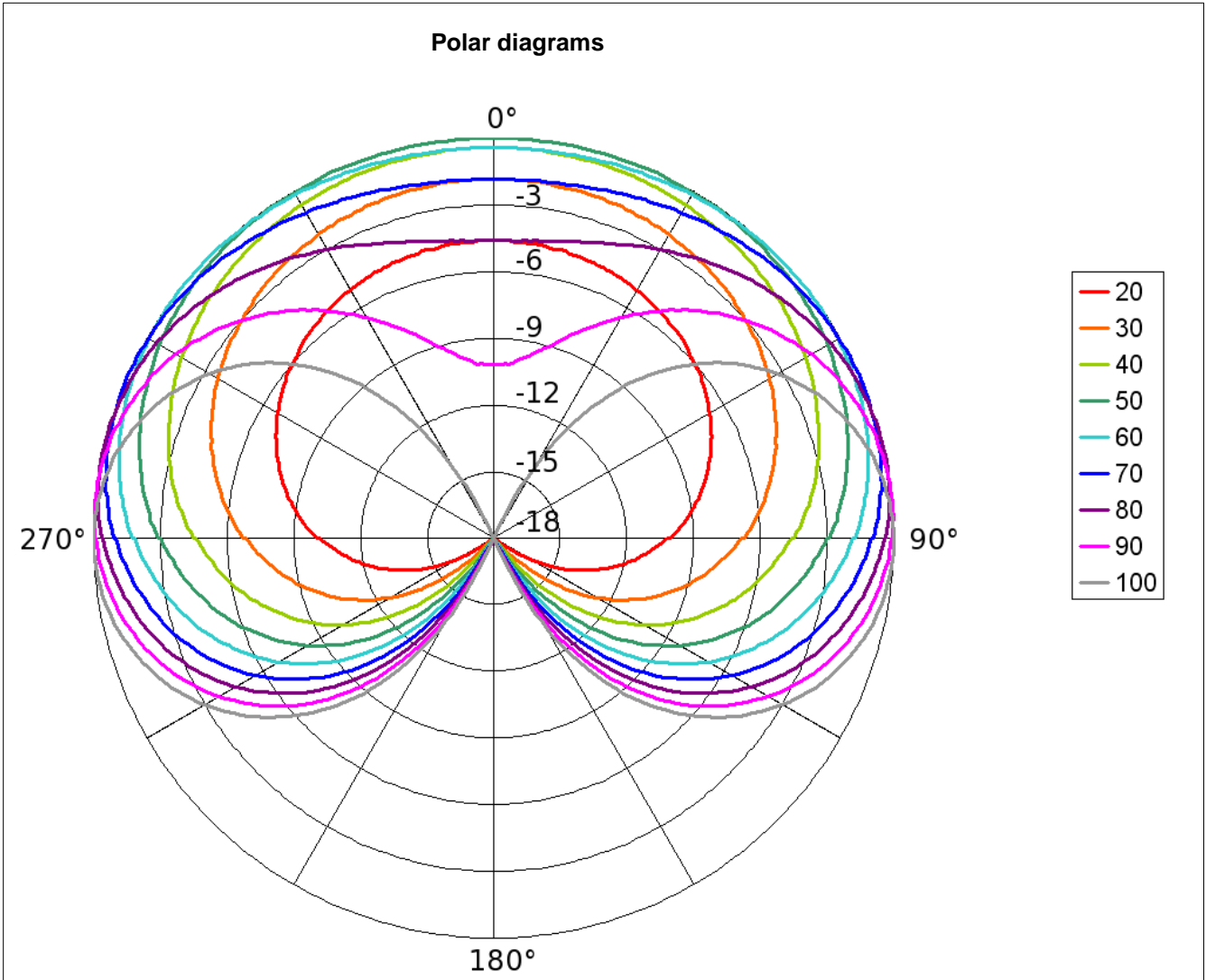

It can be seen that there is perfect cancellation behind (at 180°) and different sums in front at the various frequencies.

Practical procedure

First of all, it is necessary to establish the distances at which the subs are positioned, the times to set in the DSPs and, for these, the “centre” frequency must be decided, in relation to which the other parameters will be calculated.

1. Consider the component’s passband (let’s suppose it is from 20 Hz to 90 Hz);
2. We choose the central frequency knowing that at half of it there is an addition of 3dB and at double there is complete cancellation (see previous graphs): for example, we choose ***f = 45 Hz***;
3. we therefore calculate the relative wavelength, knowing the speed of sound (***c = 343 m/s***), i.e. $\lambda = c/f$, in our case $\lambda = 7.56 \text{ m}$;
4. We position the rear sub at a distance ***d*** equal to $\lambda/4$ of the front one, i.e. at ***1.9 m***;
5. We invert the phase and delay the rear sub by the same amount, equal to ***d/c***, i.e. ***5.54 ms***.

The following are the constants and calculation formulae:

- ***speed of sound: c = 343 m/s (at 20°C)***

- **wavelength:** $\lambda = c/f$
- **distance between the subs:** $d = \lambda/4$
- **DSP delay:** $\tau = d/c$

REMEMBER TO INVERT THE REAR SUB'S PHASE

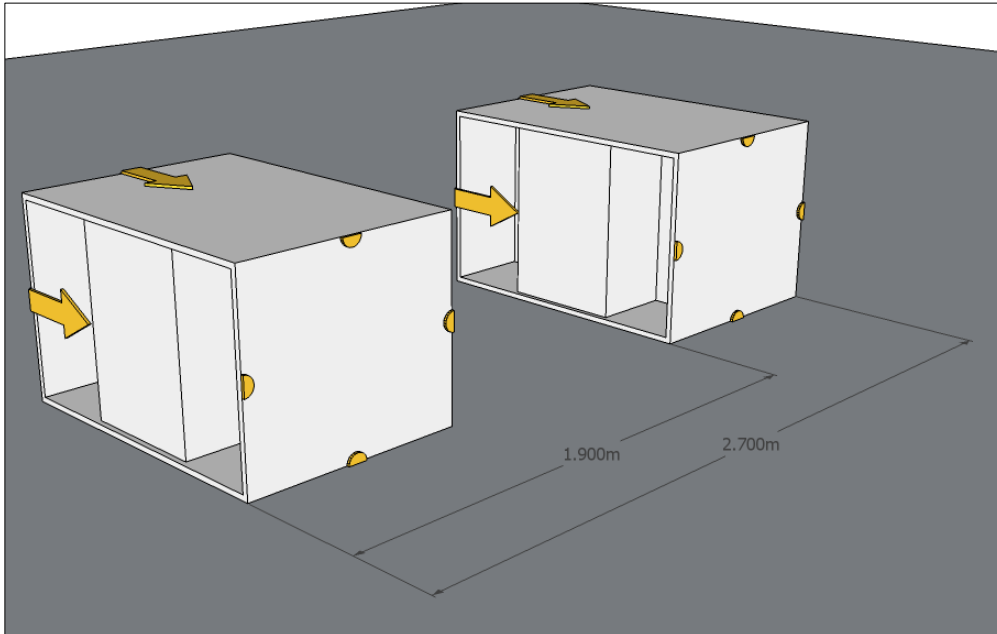

Once the distances are decided and the subs positioned, it is advisable to carry out acoustic measurements in the point in which the cancellation is required to obtain a good cardioid effect. In greater detail:

1. position the microphone in the centre between the two (perfectly aligned) subs;
2. turn on just the front sub, measure the frequency response and store the curve (red in the following figure);
3. turn on just the rear sub and take another measurement (blue curve);
4. adjust the level and equalize the rear sub in order that the two responses overlap as much as possible;

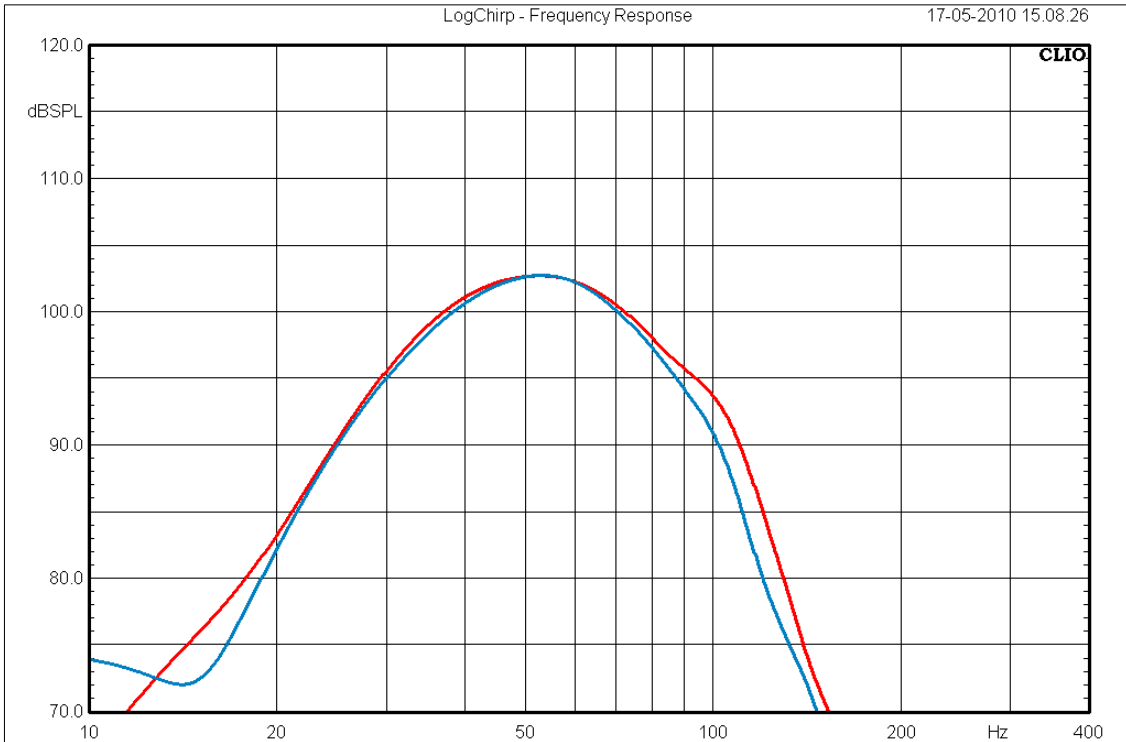

5. set the delay of the rear sub in order to align it with the front one;
6. invert the phase of the rear sub.

Turning on both subs and measuring the response frequency of the entire system, great rear reduction (green curve) is obtained.

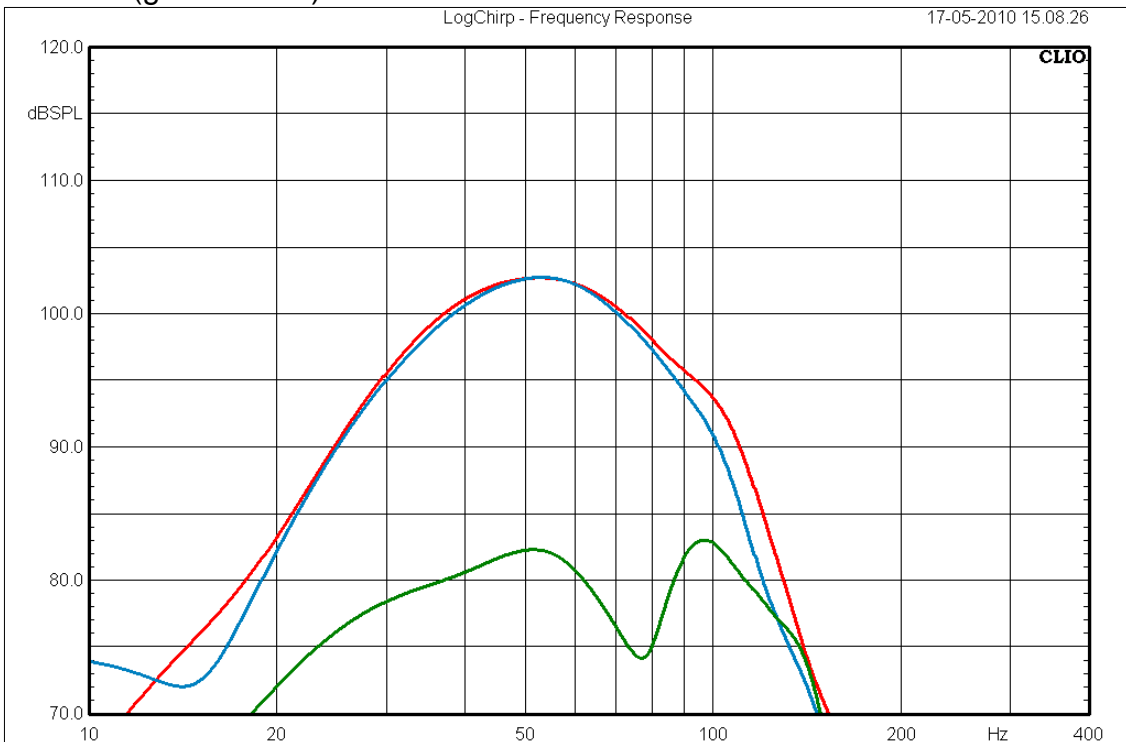

Measuring the response in front of the system, it can be seen that, compared with the single front sub (following figure, orange curve), the entire system (violet curve) has a clear addition around the frequency we chose (45 Hz), and cancellation at double the frequency (90 Hz).

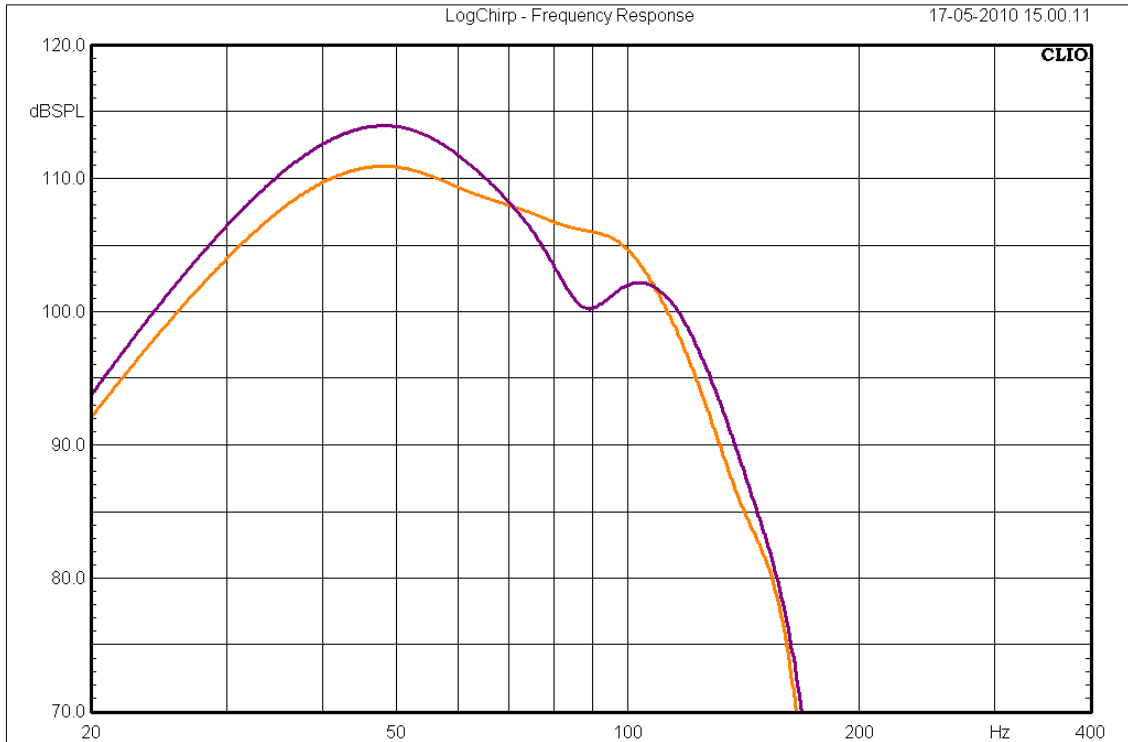

It can be noted how the sum is different from the 6 dB foreseen by the model: this is due to the changes made to the rear sub, necessary for good rear cancellation.

Outline carries out on-going research for product improvement. New materials, manufacturing methods and design upgrades are introduced to existing products without prior notice as a routine result of this philosophy. For this reason, any current Outline product may differ in some aspect from its description, but will always equal or exceed the original design specifications unless otherwise stated.

© Outline 2011
Operating manual product code: Z OMGTO
Release: 111107
Printed in Italy