



APPLICATIONS:

Live Performance
Karaoke
Audio Visual Presentations
PA Systems
Foreground Music Systems
House of Worship

BE-1520 The BE-1520 is a 2-way full range loudspeaker system designed for installation or portable application equipped with 15" woofer and 3" high frequency driver on a 60° x 60° horn in a vented enclosure, offering both high fidelity and high efficiency. For high power applications, the addition of BE Series subwoofer extends and increases the total low frequency output power with solid bass punch. The BE-1520 is made from durable MDF and plywood coated with black paint and a rugged steel grille. Included are rigging points, tripod adapter and NL4 input connectors.

SYSTEM COMPONENTS

Enclosure:
15 mm MDF plus plywood

Low Frequency Transducers:
15"

High Frequency Transducer:
3"

Input Connectors:
NL4 Speakon 2+ 2-

Grille:
Black coated perforated steel

Rigging points:
12

Tripod adapter:
Included

ACOUSTIC AND ELECTRICAL

System Type:
Full Range

Impedance:
8 Ω

Crossover Network:
2 way

Frequency Response:
49 Hz to 18 kHz ± 3 dB

Sensitivity:
104 dB SPL(1W/1M)

Dispersion:
60° x 60°

Power Handling:
500 W RMS

Finish:
Black

Dimensions:
47 cm x 74 cm x 45 cm

Weight:
36 kg

Shipping Dimensions:
53 cm x 84 cm x 53 cm

Shipping Weight:
43 kg

BAG END Loudspeakers
22N272 Pepper Road
Lake Barrington, Illinois
60010 USA
Voice 847 382 4550
Fax 847 382 4551
www.bagend.com



**BAG
END**

BE-1520

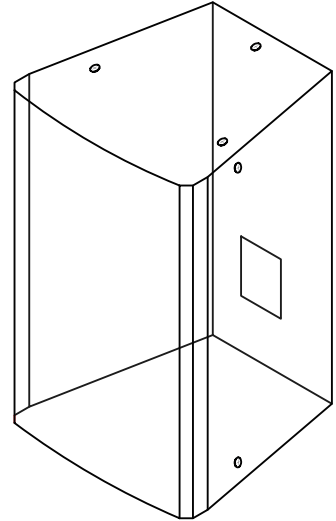

TOP

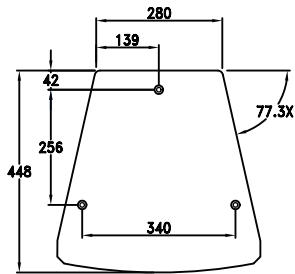

BOTTOM

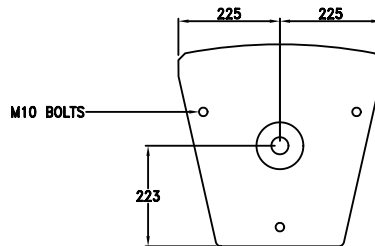

LEFT SIDE

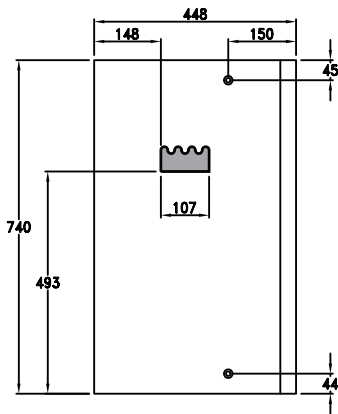

FRONT

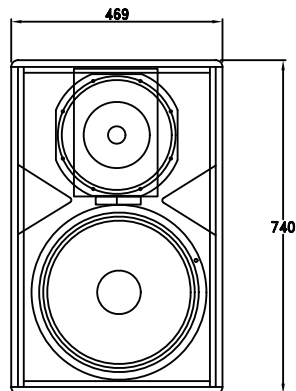

RIGHT SIDE

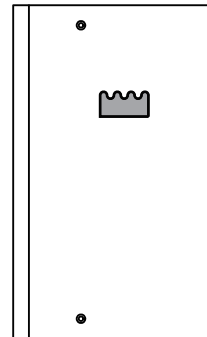

BACK

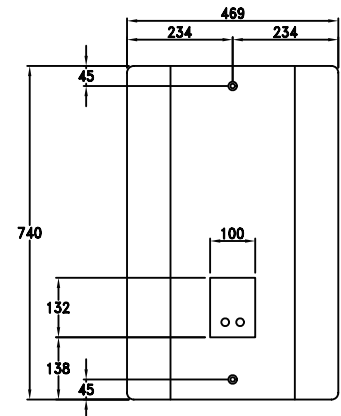

SYSTEM SCHEMATIC

