

PRX715XLF 15" Self-Powered Extended Low Frequency Subwoofer System

Features:

- ▶ Maximum SPL Output 131 dB Peak
- ▶ 15" Differential Drive® low-frequency driver for low-distortion and higher SPL
- ▶ 1500W highly efficient Class-D amplifier
- ▶ DSP input limiter circuit, crossover, dynamic limiting, and component optimization
- ▶ Professional XLR-1/4" combination inputs and XLR loop-through
- ▶ Top panel M20 pole mount socket for sub/satellite configuration
- ▶ Injection molded handles with comfort rubber grips for easy transport
- ▶ Lightweight poplar plywood cabinets made structurally sound with tongue and groove joints and protected by JBL's tour proven DuraFlex™ finish

Application:

- ▶ The PRX715XLF extended low frequency subwoofer was designed and engineered to provide sub bass frequencies with accuracy and power. Used as a single sub in a sub/sat system or in multiples as part of a scalable, large format sound reinforcement system, the PRX715XLF performs with exceptional efficiency and control. The subs are stackable and lightweight ensuring quick set-ups and tear-downs. And due to their rugged construction are perfect for AV rental inventories. With a pole receptacle (that accepts a SS4-BK or SS4-BK24) on the top panel and integrated stereo pass-thru this is the most powerful low-frequency complement to the PRX full-range systems. The addition of a polarity reverse option further enables system optimization.
- ▶ The PRX715XLF is a high performance self-powered subwoofer system. The PRX715XLF is comprised of a powerful 2275H Differential Drive® dual voice-coil and magnetic gap, woofer driven by a 1500 Watt Class-D power amplifier. Sophisticated DSP is at the core of a fully featured input section, providing user selectable cross-over functionality, polarity optimization, protection, dynamic limiting and discrete component optimization.
- ▶ All PRX700 cabinets are built from a combination of 25 mm (on the top and bottom for added rigidity) and 18 mm, strong, light-weight poplar plywood made structurally sound with tongue and groove joints. All PRX700 Series cabinets are protected by JBL's tour proven DuraFlex™ finish. Grilles are made from dent-resistant 16 gauge steel and handles are made from light-weight glass-filled nylon for added strength and durability.
- ▶ The amplifier input panel offers stereo inputs with XLR or ¼ inch jack compatibility. A user selectable crossover ensures a smooth transition to full-range system connected to the stereo outputs. Signal present and limiter lights indicate the system status and assist in setting the optimum level via the level control knob.



Specifications:

System:	System Type: Self Powered 15" subwoofer
	Maximum SPL Output: 131 dB peak
	Frequency Range (-10 dB): 37 Hz - 113 Hz
	Frequency Response (±3 dB): 44 Hz - 91 Hz
	Input Connectors: Two Balanced female XLR/ 1/4" combo connectors
	Input Impedance: 20K Ohms (balanced)
	Signal Indicators: Limit: Yellow LED indicates peak output has been reached and dsp limiter is acting Signal: Green LED indicates signal present Power/Standby: Blue indicates system has power and ready to pass audio, Red indicates system has power but is in a power saving mode and will not pass audio.
	Dynamic Control (Input): dbx Type IV™ limiter circuit
	Internal Crossover Frequency: 100 Hz DSP
	Loop out Crossover Frequency: 120 Hz analog 24 dB filter slope
Amplifier:	Design: Highly efficient Class-D amplifier
	Power Rating: 1500W
	AC Power Input: 100V - 240V ~ 50/60 Hz
Speaker:	LF Driver: 1 x JBL 2275H 15 in woofer
	Enclosure: Rectangular, 18 mm & 25 mm, plywood
	Transport: 2 x injection molded handles with backing cup
	Finish: Obsidian DuraFlex™ finish
	Grille: Powder coated, Obsidian, 16 gauge perforated steel with acoustical transparent black cloth backing.
	Dimensions (H x W x D): 547.1 mm x 445.0 mm x 580.0 mm (21.54 in x 17.52 in x 22.48 in)
	Net Weight: 25.4 kg (56.0 lb)
	Gross Weight: 30.3 kg (66.8 lb)

JBL continually engages in research related to product improvement. Some materials, production methods and design refinements are introduced into existing products without notice as a routine expression of that philosophy. For this reason, any current JBL product may differ in some respect from its published description, but will always equal or exceed the original design specifications unless otherwise stated.

► PRX715XLF 15" Self-Powered Extended Low Frequency Subwoofer System

Frequency Response:

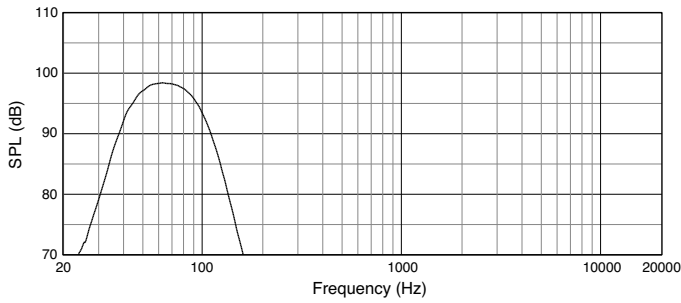

BLOCK DIAGRAM
PRX715XLF

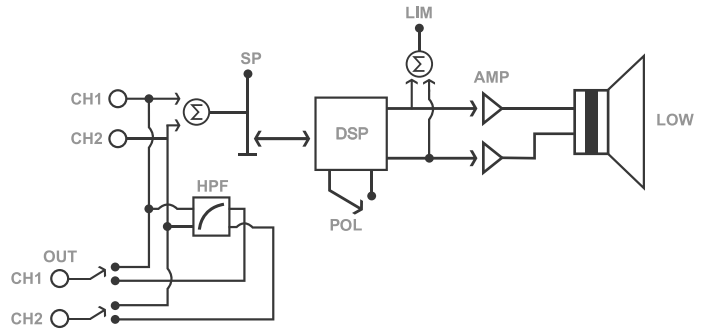

Dimensions:

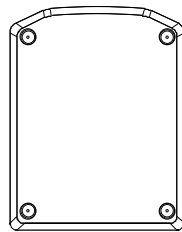
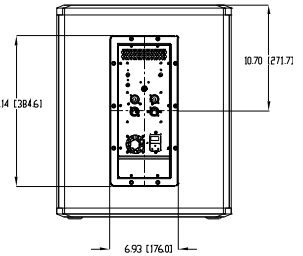
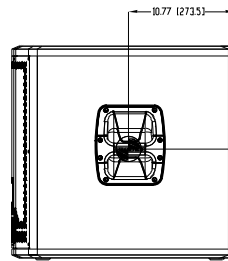
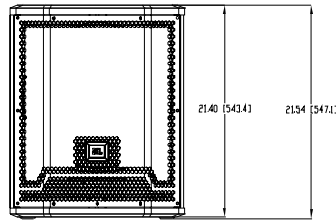
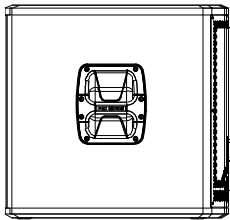
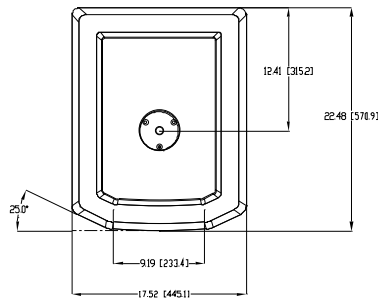

Dimensions in mm (in)



JBL Professional
8500 Balboa Boulevard, P.O. Box 2200
Northridge, California 91329 U.S.A.
© Copyright 2015 JBL Professional
www.jblpro.com

SS PRX715XLF
CRP
03/15